



erpamedikal<sup>®</sup>

Medical Products  
**Catalogue**



# history

1997

Founded in Istanbul in Erpa Medical Material Co.Ltd . Since the first years of success in the sector reached the highest level with the graphics . Hospital and medical materials company operating in the field of customer-focused work style, and has strengthened its position by never compromising on quality.

1998

Quickly Our company aims at the growth path, 1998 until today, establishing a manufacturing factory started.sustainable production material develops its own products Portfolios , customer attentiveness has managed to keep the highest among policy is to continue to face. Distribution of products made with sensitivity to the protection of the health sector and trained staff to the point where it reaches the end user is careful not to disturb the quality of the service chain.

2002

ISO 9001-2008 quality management system as a corporate structure , the company has changed the concept completely focused on customer satisfaction.

2012

Always better and more efficient service to our customers to make investments on behalf of keeping current technologies are not afraid of this understanding of our company and all of its employees in a shared does not mean the end of efforts to form the focal point.

2015

Dust and gases that create environmental pollution causes adverse effects in the lives of all living things. As a result of living with a sensitive approach to the environment and healthy communities are formed. Healthy life in economic well-being of society are called social sustainability. Based on this understanding , we are making every raw material and every product we produce as we Erp to be in a position to provide us to live in a cleaner world what ever we can.

...

Together with we we take the road to success and a bright future.

2009

Our company is registered with the National Information Bank as suppliers , goods continued to lead the industry as the registrant of the first companies in the Medical Device Directive into the national data bank .

2010

At the same time in order to better reinforce the quality system regardless of the type of products we produce are always safe and effective products as a manufacturer of medical equipment are required to possess the delivery obligations. ISO 13485: 2003 medical device initiating the work of the international standards for regulation document adopted worldwide , we have had the honor to conclude this file soon to set up our infrastructure .

2011

We took a step towards improving our machinery to be modern. By following our investments in technology , we move a little in this direction.

## *All we do is customer satisfaction and we will make*

**Erpa** as " work done, our reference " the principle is our policy not to operate continuously, once a customer. Nobody will be happy to be deceived . Moreover customers are very sensitive to the well being deceived . The customer does not want to live another experience with a deceiving himself ; It makes the people around him know it. Here are the things we've done so not on behalf finish the job , work quality, robust and we are trying to finish in an honest manner .



# *Innovative and Technological Products*

Our establishment until today , following the current technological practices in our industry and offer innovative products. We contribute to the development of the industry with our innovative products and production methods .



# index

Cabinets	6
Bedsteads And Beds	12
Physical Beds	20
Stretchers	26
Blood Collection Chairs	29
Medical Tables	32
Tool And Dressing Trolleys	37
Patient Food Tables And Nightstands	46
Laundry Trolleys	47
Stainless Steel Accessories	49
Veterinary Equipments	53
Baby Chairs	57
Screens	59
Serum Hangers	60
Medical Lamps	62
Escapes	63
Port Bowls	65
Tube Carrying Trolleys	66
Stools	67
Equipments For The Paralyzed And Disabled	68
Negatoscopes	70
Medical Waste Bins	71
Stainless Equipments	74
First Aid Equipments	77
Medical Scales	82
Other Products	85



### Single Door Cupboard

E-101

**DIMENSIONS (WxSxH)** | **WEIGHT**  
40 x 55 x 177 cm | 30 Kg

#### PROPERTIES

Antibacterial electrostatic powder paint  
ABS antistatik ikisi frenli dört adet teker  
Arm lock  
Dkp sheet metal



### Single Door Stainless Cupboard

E-101/A

**DIMENSIONS (WxSxH)** | **WEIGHT**  
40 x 55 x 177 cm | 35 Kg

#### PROPERTIES

304 Quality 18/8 chrome-nickel  
Wheel or ball-joint base  
Arm lock  
Ayarlanabilir üç adet raf



### Single Door Cupboard

E-102

**DIMENSIONS (WxSxH)** | **WEIGHT**  
40 x 55 x 177 cm | 33 Kg

#### PROPERTIES

Antibacterial electrostatic powder paint  
ABS antistatik ikisi frenli dört adet teker  
Arm locks  
Dkp sheet metal  
Alt dolap içi tek raf

## Single Door Stainless Cupboard

E-102/A

**DIMENSIONS (WxSxH)** | **WEIGHT**  
40 x 55 x 177 cm | 35 Kg

### PROPERTIES

304 Quality 18/8 chrome-nickel  
Wheel or ball-joint base  
Alt dolap içi tek raf  
Arm locks



## Double Door Cupboard

E-103

**DIMENSIONS (WxSxH)** | **WEIGHT**  
40 x 90 x 177 cm | 42 Kg

### PROPERTIES

Antibacterial electrostatic powder paint  
ABS antistatik ikisi frenli dört adet teker  
Arm lock  
Dkp sheet metal



## Double Door Cupboard

E-104

**DIMENSIONS (WxSxH)** | **WEIGHT**  
40 x 90 x 177 cm | 45 Kg

### PROPERTIES

Antibacterial electrostatic powder paint  
ABS antistatik ikisi frenli dört adet teker  
Arm lock  
Dkp sheet metal  
Alt dolap içi tek raf





### Double Door Stainless Cupboard

E-104/A

**DIMENSIONS (WxSxH)** | **WEIGHT**  
40 x 90 x 177 cm | 50 Kg

#### PROPERTIES

304 Quality 18/8 chrome-nickel  
ABS antistatik ikisi frenli dört adet teker  
Arm locks  
Alt dolap içi tek raf



### Nurse Cupboard

E-105

**DIMENSIONS (WxSxH)** | **WEIGHT**  
45 x 90 x 185 cm | 58 Kg

#### PROPERTIES

Antibacterial electrostatic powder paint  
ABS antistatik ikisi frenli dört adet teker  
Arm locks  
Dkp sheet metal  
Two drawers  
Alt dolap içi tek raf



### Nurse Cupboard

E-105/A

**DIMENSIONS (WxSxH)** | **WEIGHT**  
45 x 90 x 185 cm | 60 Kg

#### PROPERTIES

Antibacterial electrostatic powder paint  
ABS antistatik ikisi frenli dört adet teker  
Arm locks  
Two drawers  
Dkp sheet metal  
304 Quality 18/8 chrome-nickel tezgah  
Alt dolap içi tek raf



## Stainless Steel Operating Room Cupboard

E-106

**DIMENSIONS (WxSxH)** | **WEIGHT**  
45 x 90 x 185 cm | 65 Kg

### PROPERTIES

304 Quality 18/8 chrome-nickel  
Wheel or ball-joint base  
Arm locks  
Two drawers  
Ayarlanabilir iki adet raf  
Alt dolap içi tek raf



## Cap-Bonnet Cupboard

E-106/B

**DIMENSIONS (WxSxH)** | **WEIGHT**  
42 x 65 x 157 cm | 34 Kg

### PROPERTIES

304 Quality 18/8 chrome-nickel  
Six segments  
Half opening vertical drawer in the bottom segment  
Ball joint bases



## Stainless Tool And Medicine Cupboard

E-107

**DIMENSIONS (WxSxH)** | **WEIGHT**  
40 x 90 x 180 cm | 55 Kg

### PROPERTIES

304 Quality 18/8 chrome-nickel  
Wheel or ball-joint base  
Arm lock  
Ayarlanabilir üç adet raf





### Single Door Locker

E-108

**DIMENSIONS (WxSxH)** | **WEIGHT**  
40 x 42 x 185 cm | 30 Kg

#### PROPERTIES

Antibacterial electrostatic powder paint  
Arm lock  
Dkp sac  
Fixed bases



### Double Locker

E-109

**DIMENSIONS (WxSxH)** | **WEIGHT**  
40 x 80 x 185 cm | 20 Kg

#### PROPERTIES

Antibacterial electrostatic powder paint  
Arm locks  
Dkp sheet metal  
Fixed bases



### File Cupboard

E-110

**DIMENSIONS (WxSxH)** | **WEIGHT**  
42 x 92 x 130 cm | 47 Kg

#### PROPERTIES

Antibacterial electrostatic powder paint  
Arm locks  
Two covers  
Dolap içi raflı



### Narcotics Cupboard

E-111

**DIMENSIONS (WxSxH)** | **WEIGHT**  
40 x 90 x 177 cm | 20 Kg

#### PROPERTIES

Antibacterial electrostatic powder paint  
ABS antistatik ikisi frenli dört adet teker  
Arm locks  
Dkp sheet metal  
Dolap içi 3 adet ayarlanabilir raf



### Tool And Narcotics Cupboard

E-111/A

**DIMENSIONS (WxSxH)** | **WEIGHT**  
40 x 90 x 177 cm | 45 Kg

#### PROPERTIES

Antibacterial electrostatic powder paint  
ABS antistatik ikisi frenli dört adet teker  
Arm locks  
Dkp sheet metal  
Alet ve malzeme için üst bölüm  
Narkotik ilaçlar için alt bölüm  
Alt dolap için tek raf



### Narcotics Cupboard

E-112

**DIMENSIONS (WxSxH)** | **WEIGHT**  
18 x 60 x 50 cm | 9 Kg

#### PROPERTIES

Antibacterial electrostatic powder paint  
Green-red doors  
Dkp sheet metal  
Locked covers



### Narcotics Cupboard

E-112/A

**DIMENSIONS (WxSxH)** | **WEIGHT**  
18 x 30 x 50 cm | 5 Kg

#### PROPERTIES

Antibacterial electrostatic powder paint  
Locked cover  
Dkp sheet metal  
Single door  
Red or green door



### Medicine Cupboard

E-113

**DIMENSIONS (WxSxH)** | **WEIGHT**  
Small: 10 x 46 x 30 cm | 4 Kg  
Large: 12x 56 x 37 cm | 5 Kg

#### PROPERTIES

Antibacterial electrostatic powder paint  
Sliding glass cover  
Dkp sheet metal  
Wall mount



### Two Sided Manual Bedstead

E-152

**DIMENSIONS (WxSxH)** | **WEIGHT**  
100 x 200 x 45 cm | 52 Kg

**PROPERTIES**

Head and leg parts are movable  
Antibacterial electrostatic powder paint  
ABS antistatik ikisi frenli dört adet teker  
Nickel plated railing  
Wooden head piece  
Serum hangers

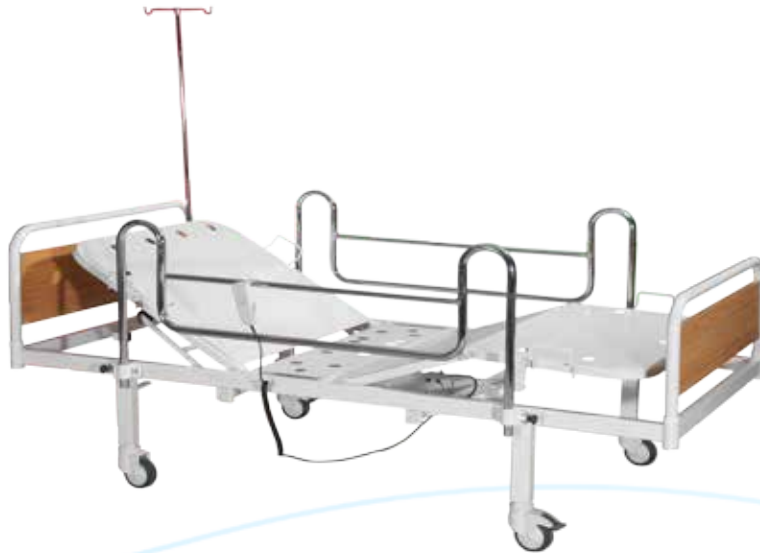

### Two Sided Electric Bedstead

E-152/A

**DIMENSIONS (WxSxH)** | **WEIGHT**  
100 x 200 x 45 cm | 60 Kg

**PROPERTIES**

Electric-motors head and leg parts are movable  
Antibacterial electrostatic powder paint  
ABS antistatik ikisi frenli dört adet teker  
Nickel plated railing  
Wooden head piece  
Serum hangers  
Hand remote



### Two Sided Electric Bedstead

E-152/B

**DIMENSIONS (WxSxH)** | **WEIGHT**  
100 x 200 x 45 cm | 62 Kg

**PROPERTIES**

Electric-motors head and leg parts are movable  
Antibacterial electrostatic powder paint  
ABS antistatik ikisi frenli dört adet teker  
Aluminium plated railing  
ABS head piece  
Serum hangers  
Hand remote



## Two Sided Electric Bedstead

E-152/C

**DIMENSIONS (WxSxH)** | **WEIGHT**  
100 x 200 x 45 cm | 75 Kg

### PROPERTIES

- Electric-motors head and leg parts are movable
- Antibacterial electrostatic powder paint
- ABS antistatik ikisi frenli dört adet teker
- ABS plated railing
- ABS head piece
- Serum hangers
- Hand remote





### Two Sided Electric Bedstead

E-153

**DIMENSIONS (WxSxH)** | **WEIGHT**  
100 x 200 x 45 cm | 80 Kg

#### PROPERTIES

Electric-motors head and leg parts are movable  
Antibacterial electrostatic powder paint  
ABS antistatik ikisi frenli dört adet teker  
ABS plated railing  
ABS head piece  
Serum hangers  
Hand remote



### Two Sided Electric Bedstead

E-153/A

**DIMENSIONS (WxSxH)** | **WEIGHT**  
100 x 200 x 45 cm | 65 Kg

#### PROPERTIES

Electric-motors head and leg parts are movable  
Antibacterial electrostatic powder paint  
ABS antistatik ikisi frenli dört adet teker  
Aluminium plated railing  
Wooden head piece  
Serum hangers  
Hand remote



### Two Sided Manual Bedstead With Trendelenburg

E-154

**DIMENSIONS (WxSxH)** | **WEIGHT**  
100 x 200 x 50 cm | 65 Kg

#### PROPERTIES

Antibacterial electrostatic powder paint  
Manual movement head and leg part are movable  
ABS antistatik ikisi frenli dört adet teker  
Amortisör vasıtası ile ters ve düz trendelenburg hareketi  
Aluminium plated railing  
ABS head piece  
Serum hangers



### Electric Bedstead With Three Motors

E-155

**DIMENSIONS (WxSxH)** | **WEIGHT**  
100 x 200 x 55-95 cm | 85 Kg

**PROPERTIES**

- Electric-motors head and leg parts are movable
- Antibacterial electrostatic powder paint
- ABS antistatik ikisi frenli dört adet teker
- ABS head piece
- Aluminium plated railing
- Serum hangers
- Hand remote

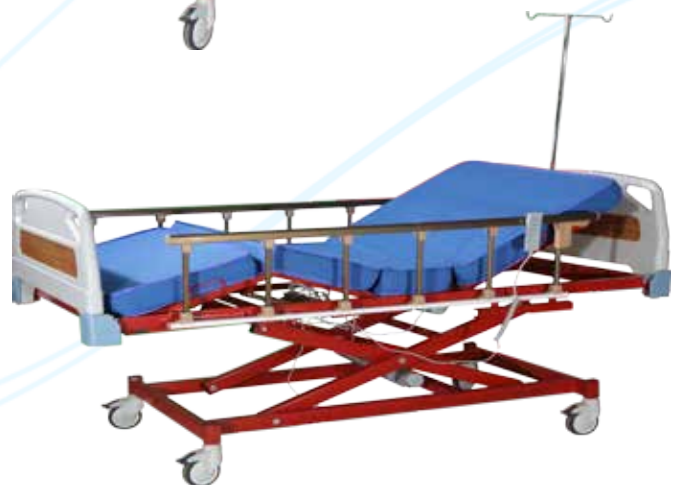

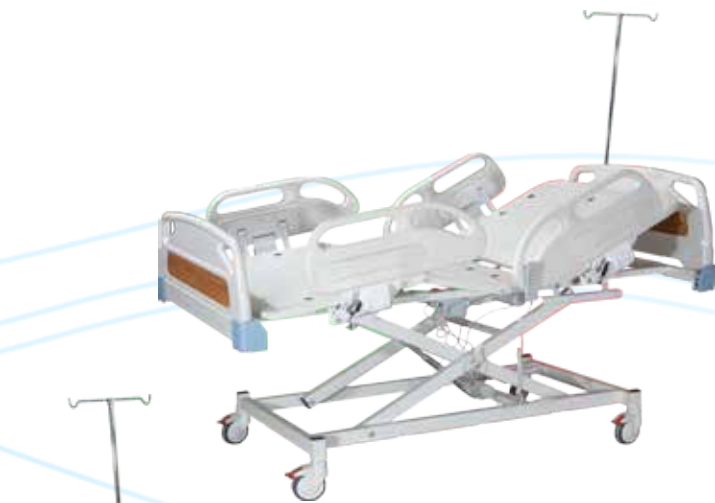

### Electric Bedstead With Three Motors

E-155/A

**DIMENSIONS (WxSxH)** | **WEIGHT**  
100 x 200 x 55-95 cm | 100 Kg

- PROPERTIES**
- Electric-motors head and leg parts are movable
  - Antibacterial electrostatic powder paint
  - ABS antistatik ikisi frenli dört adet teker
  - ABS head piece
  - ABS plated railing
  - Serum hangers
  - Hand remote



## Two Sided Electric Bedstead With Trendelenburg

E-156

**DIMENSIONS (WxSxH)** | **WEIGHT**  
100 x 200 x 50 cm | 65 Kg

### PROPERTIES

Antibacterial electrostatic powder paint  
Head and leg pieces move via the electric-motor  
ABS antistatik ikisi frenli dört adet teker  
Amortisör vasıtası ile ters ve düz trendelenburg hareketi  
Aluminium plated railing  
ABS head piece  
Serum hangers  
Hand remote



## Baby Bedstead

E-157

**DIMENSIONS (WxSxH)** | **WEIGHT**  
66 x 75 x 95 cm | 16 Kg

### PROPERTIES

Antibacterial electrostatic powder paint  
Antistatik ABS wheels



## Child Bedstead

E-157/A

**DIMENSIONS (WxSxH)** | **WEIGHT**  
70 x 140 x 100 cm | 25 Kg

### PROPERTIES

Antibacterial electrostatic powder paint  
Movable two sided railing  
Head pieces move via the electric-motor  
Disassembled  
Hand remote

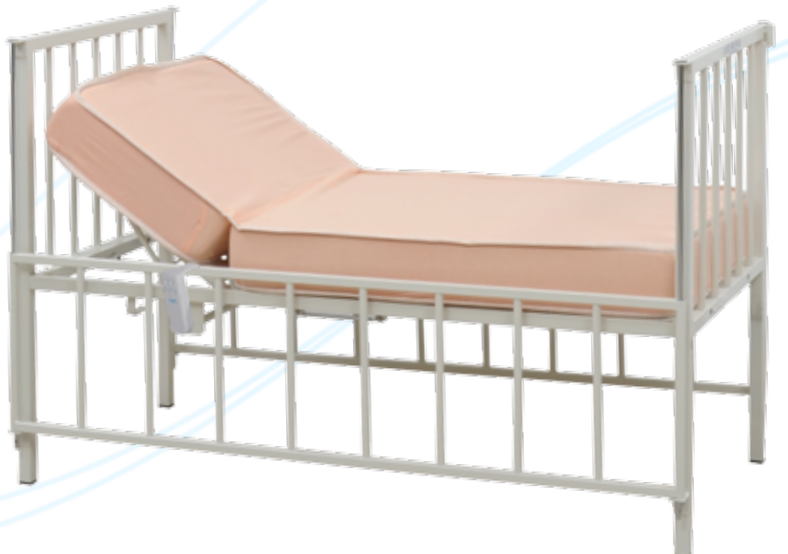



### Child Bedstead

E-158

**DIMENSIONS (WxSxH)** | **WEIGHT**  
70 x 140 x 100 cm | 20 Kg

#### PROPERTIES

Antibacterial electrostatic powder paint  
Movable sided railing  
Disassembled



### Child Bedstead

E-158/A

**DIMENSIONS (WxSxH)** | **WEIGHT**  
70 x 140 x 100 cm | 25 Kg

#### PROPERTIES

Head piece movement via the hand valve  
Antibacterial electrostatic powder paint  
Movable sided railing  
Disassembled



### Child Bedstead

E-158/B

**DIMENSIONS (WxSxH)** | **WEIGHT**  
70 x 150 x 45 cm | 35 Kg

#### PROPERTIES

Antibacterial electrostatic powder paint  
ABS antistatik ikisi frenli dört adet teker  
ABS head piece  
ABS plated railing  
Head piece movement via the electric-motor  
Hand remote



### Ortopedik Karyola Yatağı

E-159

**DIMENSIONS (WxSxH)** | **WEIGHT**  
90 x 190 x 12 cm | 8 Kg

#### PROPERTIES

28 density foam  
Single piece  
Lazer kesim ortopedik sünger  
Antibacterial and waterproof fabric



## Dört Motorlu Karyola

E-161

**DIMENSIONS (WxSxH)** | **WEIGHT**  
105 x 210 x 55-95 cm | 110 Kg

### PROPERTIES

Antibacterial electrostatic powder paint  
Elektrik motorlu baş, ayak ve yükseklik hareketleri  
Ters ve düz trendelenburg hareketi  
ABS başlık ve korkuluklar  
ABS antistatik ikisi frenli dört adet teker  
Serum hangers  
Hand remote

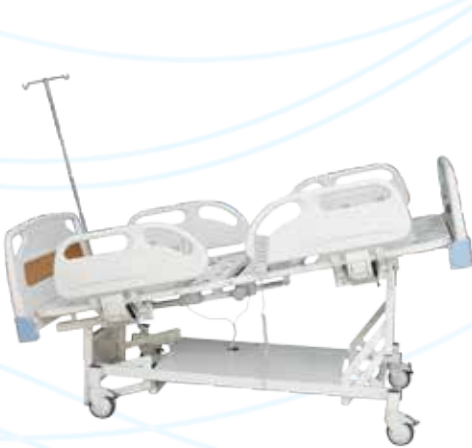



### Examination Tables

E-201

**DIMENSIONS (WxSxH)** | **WEIGHT**  
56 x 185 x 70 cm | 25 Kg

#### PROPERTIES

Antibacterial electrostatic powder paint  
Antibacterial upholstery  
Four-level manual head adjustment  
Leg piece foldable  
30x30 1,20 profile frame



### Examination Tables

E-202

**DIMENSIONS (WxSxH)** | **WEIGHT**  
56 x 185 x 70 cm | 25 Kg

#### PROPERTIES

Antibacterial electrostatic powder paint  
Antibacterial upholstery  
Four-level manual head adjustment  
Fixed leg piece



### Examination Tables

E-202/A

**DIMENSIONS (WxSxH)** | **WEIGHT**  
56 x 185 x 65 cm | 35 Kg

#### PROPERTIES

Antibacterial electrostatic powder paint  
Antibacterial upholstery  
Four-level manual head adjustment  
Fixed leg piece  
Sac dolap ve çekmece



### Examination Tables

E-202/B

**DIMENSIONS (WxSxH)** | **WEIGHT**  
56 x 185 x 70 cm | 30 Kg

#### PROPERTIES

Antibacterial electrostatic powder paint  
Antibacterial upholstery  
Four-level manual head adjustment  
Fixed leg piece  
iki adet metal çekmece



### Examination Tables

E-202/C

**DIMENSIONS (WxSxH)** | **WEIGHT**  
56 x 185 x 70 cm | 28 Kg

#### PROPERTIES

Antibacterial electrostatic powder paint  
Antibacterial upholstery  
Four-level manual head adjustment  
ABS antistatik ikisi frenli dört adet teker



### Examination Tables

E-203

**DIMENSIONS (WxSxH)** | **WEIGHT**  
56 x 185 x 65 cm | 22 Kg

#### PROPERTIES

Antibacterial electrostatic powder paint  
Antibacterial upholstery  
Manual head and leg piece adjustment with damper  
Fixed leg piece



### Massage Bed

E-204

**DIMENSIONS (WxSxH)** | **WEIGHT**  
56 x 185 x 70 cm | 25 Kg

#### PROPERTIES

Antibacterial electrostatic powder paint  
Antibacterial upholstery  
Four-level manual head adjustment  
Leg piece foldable  
Face hole system  
30 x 30 1,20 mm profile frame



### Examination Tables

E-205

**DIMENSIONS (WxSxH)** | **WEIGHT**  
60 x 185 x 80 cm | 45 Kg

#### PROPERTIES

Full wood-work  
Antibacterial upholstery  
Four-level manual head adjustment  
Fixed leg piece  
28 Density 5 cm grey foam  
Paper towel holder  
Çift taraflı kullanılabilir üst platform  
Two drawers



### Massage Bed

E-204/A

**DIMENSIONS (WxSxH)** | **WEIGHT**  
60 x 185 x 80 cm | 45 Kg

#### PROPERTIES

Full wood-work  
Antibacterial upholstery  
Four-level manual head adjustment  
Fixed leg piece  
28 Density 5 cm grey foam  
Paper towel holder  
Çift taraflı kullanılabilir üst platform  
Two drawers  
Face hole system

## Examination Tables

E-205/A

**DIMENSIONS (WxSxH)** | **WEIGHT**  
60 x 185 x 80 cm | 45 Kg

### PROPERTIES

Full wood-work  
Antibacterial upholstery  
Four-level manual head adjustment  
Fixed leg piece  
28 Density 5 cm grey foam  
Paper towel holder  
Çift taraflı kullanılabilir üst platform  
Two drawers



## Examination Tables

E-206

**DIMENSIONS (WxSxH)** | **WEIGHT**  
60 x 185 x 80 cm | 45 Kg

### PROPERTIES

Full wood-work  
Antibacterial upholstery  
Four-level manual head adjustment  
Fixed leg piece  
28 Density 5 cm grey foam  
Paper towel holder  
Çift taraflı kullanılabilir üst platform  
Two drawers



## Examination Tables

E-206/A

**DIMENSIONS (WxSxH)** | **WEIGHT**  
60 x 185 x 80 cm | 45 Kg

### PROPERTIES

Full wood-work  
Antibacterial upholstery  
Four-level manual head adjustment  
Fixed leg piece  
28 Density 5 cm grey foam  
Paper towel holder  
Çift taraflı kullanılabilir üst platform  
Two drawers





### Examination Tables

E-207

**DIMENSIONS (WxSxH)** | **WEIGHT**  
60 x 185 x 70 cm | 40 Kg

#### PROPERTIES

30x30 profile  
Antibacterial electrostatic powder paint  
Antibacterial upholstery  
Fixed leg piece  
Shiny wood sheathed borders



### Massage Bed

E-207/A

**DIMENSIONS (WxSxH)** | **WEIGHT**  
60 x 185 x 70 cm | 40 Kg

#### PROPERTIES

30x30 profile  
Antibacterial electrostatic powder paint  
Antibacterial upholstery  
Fixed leg piece  
Shiny wood sheathed borders  
Masaj başlığı







## Examination Tables

**DIMENSIONS (WxSxH)** | **WEIGHT**  
60 x 185 x 50-100 cm | 45 Kg

### PROPERTIES

Antibacterial electrostatic powder paint  
ABS antistatik ikisi frenli dört adet teker  
Head piece movement with damper  
Hand remote

E-210





## Portable Stretcher

E-211

**DIMENSIONS (WxSxH)** | **WEIGHT**  
60 x 220 x 22 cm | 8 Kg

### PROPERTIES

Antibacterial electrostatic powder paint  
PVC antibacterial brenda  
In two endure  
32x1,20 mm pipe



## Stretcher

E-212

**DIMENSIONS (WxSxH)** | **WEIGHT**  
60 x 185 x 80 cm | 40 Kg

### PROPERTIES

Antibacterial electrostatic powder paint  
Antibakteriyel sıvı geçirmez üst minder  
ABS antistatik ikisi frenli dört adet teker  
Serum hangers  
Tube and tool holding apparatus  
Stretcher: 68 x 185 x 47 cm  
Alt araba: 60 x 110 x 80 cm



## Stretcher

E-213

**DIMENSIONS (WxSxH)** | **WEIGHT**  
60 x 185 x 80 cm | 40 Kg

### PROPERTIES

Antibacterial electrostatic powder paint  
Antibakteriyel sıvı geçirmez üst minder  
200 mm wheel  
Serum hangers  
Tube and tool holding apparatus  
stretcher: 68 x 185 x 47 cm  
Alt araba: 60 x 110 x 80 cm

## Patient Transfer Stretcher

E-214

**DIMENSIONS (WxSxH)** | **WEIGHT**  
65 x 185 x 80 cm | 55 Kg

### PROPERTIES

Antibacterial electrostatic powder paint  
Antibakteriyel sıvı geçirmez üst minder  
200 mm wheel  
Serum hangers  
Alt arabalar kilitlenebilir  
Alt araba ölçüsü: 60 x 155 x 65 cm



## Hydraulics Stretcher

E-215

**DIMENSIONS (WxSxH)** | **WEIGHT**  
70 x 200 x 65-105 cm | 75 Kg

### PROPERTIES

Antibacterial electrostatic powder paint  
Antibakteriyel sıvı geçirmez üst minder  
200 mm wheel  
Inverse and normal trendelenburg  
Aluminum profile chairs  
Height adjustment with hydraulic pedal  
Tube holding apparatus  
Serum hangers



## Hydraulics Stretcher

E-216

**DIMENSIONS (WxSxH)** | **WEIGHT**  
70 x 200 x 65-105 cm | 75 Kg

### PROPERTIES

Antibacterial electrostatic powder paint  
Antibakteriyel sıvı geçirmez üst minder  
200 mm wheel  
Inverse and normal trendelenburg  
Height adjustment with hydraulic pedal  
Tube holding apparatus  
Serum hangers  
Nikelaj korkuluk





### Hydraulics Stretcher

E-215/A

**DIMENSIONS (WxSxH)** | **WEIGHT**  
70 x 200 x 65-105 cm | 75 Kg

#### PROPERTIES

Antibacterial electrostatic powder paint  
Antibakteriyel sıvı geçirmez üst minder  
Antistatic 200 mm wheel  
Inverse and normal trendelenburg  
Height adjustment with hydraulic pedal  
Tube holding apparatus  
Serum hangers  
ABS antibacterial chairs



## Blood Collection Chairs

E-217

**DIMENSIONS (WxSxH)** | **WEIGHT**  
80 x 165 x 48 cm | 40 Kg

### PROPERTIES

Antibacterial electrostatic powder paint  
Antibakteriyel ve alev almaz döşeme  
Amortisör ile sırt yatma  
Eş zamanlı sırt ve ayak hareketi  
Seat dimensions: 53 x 50 cm  
28 Density 5 cm grey foam



## Blood Collection Chairs

E-217/B

**DIMENSIONS (WxSxH)** | **WEIGHT**  
80 x 165 x 55 cm | 45 Kg

### PROPERTIES

Antibacterial electrostatic powder paint  
Antibakteriyel ve alev almaz döşeme  
ABS antistatik ikisi frenli dört adet teker  
Amortisör ile sırt yatma  
Eş zamanlı sırt ve ayak hareketi  
Seat dimensions: 53 x 50 cm  
28 Density 5 cm grey foam



## Blood Collection Chairs

E-218

**DIMENSIONS (WxSxH)** | **WEIGHT**  
90 x 70 x 90 cm | 13 Kg

### PROPERTIES

Antibacterial electrostatic powder paint  
Antibacterial upholstery  
Oturma yerden yükseklik: 43 cm





## General Purpose Chairs

E-219

**DIMENSIONS (WxSxH)** | **WEIGHT**  
65 x 170 x 50-90 cm | 90 Kg

### PROPERTIES

Electro-mechanical  
Her pozisyona getirebilme özelliđi  
Ergonomik dizayn  
Four-position memory  
Tek tuşla başlangıç pozisyonu (Sıfırlama)  
Çift mafsallı her konuma getirilebilme ve tek harekette kilitlenebilir başlık  
Right armrest may be opened  
Antibacterial upholstery



## Blood Collection Chairs

E-220

**DIMENSIONS (WxSxH)** | **WEIGHT**  
80 x 165 x 48 cm | 41 Kg

### PROPERTIES

Antibacterial electrostatic powder paint  
Antibakteriyel ve alev almaz döşeme  
With electric-motor  
Hand remote  
Back and leg movement is synchronized  
Seat dimensions: 53 x 50 cm  
28 Density 5 cm grey foam



## Blood Collection Chairs

E-220/A

**DIMENSIONS (WxSxH)** | **WEIGHT**  
80 x 165 x 48 cm | 41 Kg

### PROPERTIES

Antibacterial electrostatic powder paint  
Antibakteriyel ve alev almaz döşeme  
With dampers  
Back and leg movement is synchronized  
Seat dimensions: 53 x 50 cm  
28 Density 5 cm grey foam

## Blood Collection Chairs

E-220/B

**DIMENSIONS (WxSxH)** | **WEIGHT**  
80 x 175 x 48 cm | 40 Kg

### PROPERTIES

Antibacterial electrostatic powder paint  
Antibakteriyel upholstery  
Trendelenburg movement  
Hareketli başlık ve kolçaklar  
Back and leg movement is synchronized  
Hand remote  
Seat dimensions: 53 x 50 cm  
28 Density 5 cm grey foam





### Electric Gynecologic Table

E-222

**DIMENSIONS (WxSxH)** | **WEIGHT**  
70 x 170 x 50-85 cm | 55 Kg

#### PROPERTIES

Antibacterial electrostatic powder paint  
Antibacterial upholstery  
ABS antistatik ikisi frenli dört adet teker  
Electro-mechanical motor system  
Independent back and leg movement  
Trendelenburg movement  
Ayak pedali ile kontrol  
28 Density 5 cm grey foam  
Ayak pedali ya da el kumandası seçeneği



## Gynecologic Table

E-221

**DIMENSIONS (WxSxH)** | **WEIGHT**  
70 x 170 x 95 cm | 40 Kg

### PROPERTIES

Antibacterial electrostatic powder paint  
Antibakteriyel upholstery  
Trendelenburg movement  
Leg movement  
Seat dimensions: 54 x 48 cm  
28 Density 5 cm grey foam  
Serum hangers



## Obstetrical Table

E-223

**DIMENSIONS (WxSxH)** | **WEIGHT**  
70 x 220 x 80 cm | 58 Kg

### PROPERTIES

Antibacterial electrostatic powder paint  
Antibacterial upholstery  
ABS antistatik ikisi frenli dört adet teker  
Trendelenburg movement  
28 Density 5 cm grey foam  
Tekerli ek masa ölçüsü: 65x100 cm





### ENT Examination Chairs

E-224

**DIMENSIONS (WxSxH)** | **WEIGHT**  
65 x 165 x 50-80 cm | 90 Kg

#### PROPERTIES

Electro-mechanical  
Her pozisyona getirebilme özelliği  
Ergonomic design  
Four-position memory  
Tek tuşla başlangıç pozisyonu (Sıfırlama)  
Tek hareketle kilitlenebilen başlık  
Antibacterial upholstery



### ENT Examination Chairs

E-224/A

**DIMENSIONS (WxSxH)** | **WEIGHT**  
65 x 165 x 45-85 cm | 90 Kg

#### PROPERTIES

Double telescopic hydraulic system  
Revolves around itself at 360 degrees  
Right armrest may be opened  
Antibacterial upholstery

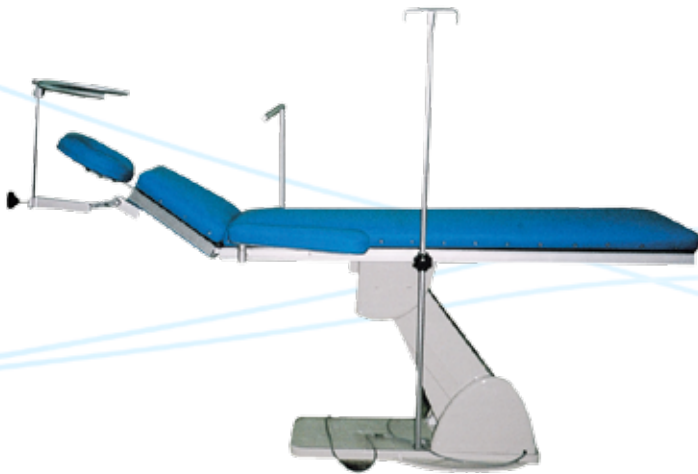

### Operation Table

E-224/B

**DIMENSIONS (WxSxH)** | **WEIGHT**  
65 x 175 x 50-90 cm | 85 Kg

#### PROPERTIES

Electro-mechanical  
With leg control (Hand control is optional)  
Antibacterial upholstery  
Serum hangers  
Four-position memory

## Proctology Table

E-225

**DIMENSIONS (WxSxH)** | **WEIGHT**  
60 x 160 x 85 cm | 37 Kg

### PROPERTIES

Antibacterial electrostatic powder paint  
Antibacterial upholstery  
Mechanical  
Serum hangers



## ENT Examination Chairs

E-226

**DIMENSIONS (WxSxH)** | **WEIGHT**  
65 x 165 x 50-90 cm | 85 Kg

### PROPERTIES

Electro-mechanical  
Ergonomic design  
Otomatik toplama  
Four-position memory  
Revolves around itself at 360 degrees  
Çift mafsallı, çok hareketli başlık  
Right armrest may be opened  
Üzeri antibakteriyel ve antifungal suni deri ile kaplı



## Care Chairs

E-226/A

**DIMENSIONS (WxSxH)** | **WEIGHT**  
65 x 165 x 50-90 cm | 85 Kg

### PROPERTIES

Electro-mechanical  
Right armrest may be opened  
Antibacterial upholstery  
Damper at leg piece movement



# *Quality -Oriented Production*

Permanent "Customer Satisfaction" to provide quality products and services to produce , our basic principle is to offer the most favorable conditions them to market.

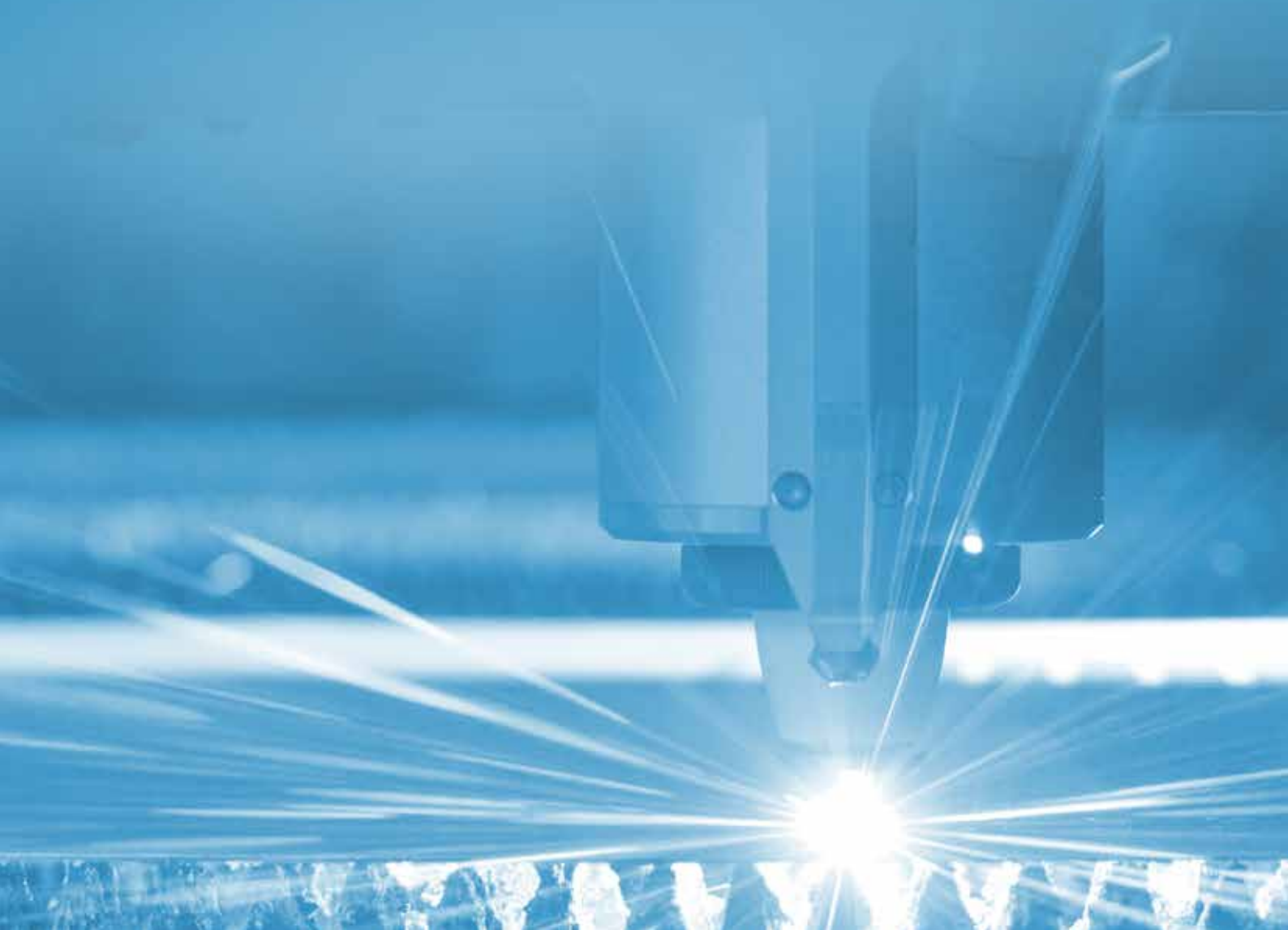



### Device Trolley

E-230

**DIMENSIONS (WxSxH)** | **WEIGHT**  
45 x 50 x 80 cm | 9 Kg

#### PROPERTIES

Antibacterial electrostatic powder paint  
ABS antistatik ikisi frenli dört adet teker  
Profile body  
Double-decked



### Device Trolley

E-230/A

**DIMENSIONS (WxSxH)** | **WEIGHT**  
45 x 50 x 80 cm | 10 Kg

#### PROPERTIES

Antibacterial electrostatic powder paint  
ABS antistatik ikisi frenli dört adet teker  
Profile body  
Triple-decked



### Device Trolley

E-231

**DIMENSIONS (WxSxH)** | **WEIGHT**  
40 x 65 x 70 cm | 9 Kg

#### PROPERTIES

Antibacterial electrostatic powder paint  
ABS antistatik ikisi frenli dört adet teker  
Profile body  
Z type  
Double-decked



### Device Trolley

E-231/A

**DIMENSIONS (WxSxH)** | **WEIGHT**  
40 x 65 x 71 cm | 15 Kg

#### PROPERTIES

Antibacterial electrostatic powder paint  
ABS antistatik ikisi frenli dört adet teker  
Profile body  
Drawer  
Z type



### Device Trolley

E-231/B

**DIMENSIONS (WxSxH)** | **WEIGHT**  
40 x 65 x 71 cm | 11 Kg

#### PROPERTIES

Antibacterial electrostatic powder paint  
ABS antistatik ikisi frenli dört adet teker  
Profile body  
Triple-decked  
Z type



### Device Trolley

E-232

**DIMENSIONS (WxSxH)** | **WEIGHT**  
40 x 50 x 87 cm | 8 Kg

#### PROPERTIES

Antibacterial electrostatic powder paint  
ABS antistatik ikisi frenli dört adet teker  
Profile body



### Device Trolley

E-232/A

**DIMENSIONS (WxSxH)** | **WEIGHT**  
40 x 50 x 87 cm | 12,5 Kg

#### PROPERTIES

Antibacterial electrostatic powder paint  
ABS antistatik ikisi frenli dört adet teker  
Profile body  
Drawer



### Device Trolley

E-232/B

**DIMENSIONS (WxSxH)** | **WEIGHT**  
40 x 50 x 87 cm | 8 Kg

#### PROPERTIES

Antibacterial electrostatic powder paint  
ABS antistatik ikisi frenli dört adet teker  
Profile body  
Hanger



### Device Trolley

E-232/C

**DIMENSIONS (WxSxH)** | **WEIGHT**  
40 x 50 x 155 cm | 15 Kg

#### PROPERTIES

Antibacterial electrostatic powder paint  
ABS antistatik ikisi frenli dört adet teker  
Profile body  
Triple-decked



### Device Trolley

E-233

**DIMENSIONS (WxSxH)** | **WEIGHT**  
40 x 50 x 82 cm | 10 Kg

#### PROPERTIES

Antibacterial electrostatic powder paint  
ABS antistatik ikisi frenli dört adet teker  
Profile body  
Drawer



### Device Trolley

E-233/A

**DIMENSIONS (WxSxH)** | **WEIGHT**  
40 x 50 x 82 cm | 10 Kg

#### PROPERTIES

Antibacterial electrostatic powder paint  
ABS antistatik ikisi frenli dört adet teker  
Profile body  
Drawer and hanger



### Device Trolley

E-234

**DIMENSIONS (WxSxH)** | **WEIGHT**  
51 x 50 x 80 cm | 14 Kg

#### PROPERTIES

Antibacterial electrostatic powder paint  
ABS antistatik ikisi frenli dört adet teker  
Profile body  
Drawer



**Device  
Trolley**

**E-234/A**

**DIMENSIONS (WxSxH)** | **WEIGHT**  
51 x 50 x 80 cm | 16 Kg

**PROPERTIES**

Antibacterial electrostatic powder paint  
ABS antistatik ikisi frenli dört adet teker  
Profile body  
Triple-decked  
Drawer



**Device  
Trolley**

**E-235**

**DIMENSIONS (WxSxH)** | **WEIGHT**  
45 x 85 x 87 cm | 30 Kg

**PROPERTIES**

Antibacterial electrostatic powder paint  
ABS antistatik ikisi frenli dört adet teker  
Profile body  
304 Quality 18/8 chrome-nickel üst tezgah  
Double-decked  
Kilitlenebilir dolap  
Pushing handle



**Device  
Trolley**

**E-235/A**

**DIMENSIONS (WxSxH)** | **WEIGHT**  
45 x 85 x 87 cm | 17 Kg

**PROPERTIES**

Antibacterial electrostatic powder paint  
ABS antistatik ikisi frenli dört adet teker  
Profile body  
304 Quality 18/8 chrome-nickel üst ve alt tezgah  
Drawer  
Pushing handle



**Device  
Trolley**

**E-236**

**DIMENSIONS (WxSxH)** | **WEIGHT**  
50 x 90 x 92 cm | 25 Kg

**PROPERTIES**

Antibacterial electrostatic powder paint  
ABS antistatik ikisi frenli dört adet teker  
Profile body  
Two drawers  
ABS antibacterial workbench  
Pushing handle



**Device  
Trolley**

**E-236/A**

**DIMENSIONS (WxSxH)** | **WEIGHT**  
50 x 90 x 92 cm | 30 Kg

**PROPERTIES**

Antibacterial electrostatic powder paint  
ABS antistatik ikisi frenli dört adet teker  
Profile body  
Two drawers  
Cupboard  
304 Quality 18/8 chrome-nickel alt tezgah  
ABS antibacterial workbench  
Medical waste bin  
Pushing handle



**Device  
Trolley**

**E-237**

**DIMENSIONS (WxSxH)** | **WEIGHT**  
50 x 90 x 92 cm | 25 Kg

**PROPERTIES**

Antibacterial electrostatic powder paint  
ABS antistatik ikisi frenli dört adet teker  
Profile body  
2 small and 1 large drawer  
ABS antibacterial workbench  
Pushing handle



### Dressing And Device Trolley

E-237/A

**DIMENSIONS (WxSxH)** | **WEIGHT**  
45 x 70 x 82 cm | 16 Kg

#### PROPERTIES

Antibacterial electrostatic powder paint  
ABS antistatik ikisi frenli dört adet teker  
Profile body  
Drawer  
304 Quality 18/8 chrome-nickel alt ve üst tezgah



### Dressing And Device Trolley

E-237/B

**DIMENSIONS (WxSxH)** | **WEIGHT**  
45 x 70 x 82 cm | 16 Kg

#### PROPERTIES

Antibacterial electrostatic powder paint  
ABS antistatik ikisi frenli dört adet teker  
Profile body  
Drawer  
304 Quality 18/8 chrome-nickel alt ve üst tezgah  
Pushing handle



### Dressing And Device Trolley

E-237/C

**DIMENSIONS (WxSxH)** | **WEIGHT**  
50 x 60 x 92 cm | 25 Kg

#### PROPERTIES

Antibacterial electrostatic powder paint  
ABS antistatik ikisi frenli dört adet teker  
Profile body  
Locked drawer  
ABS antibacterial workbench  
Double-decked  
Kateter koyma aparatı  
Pushing handle



### Dressing And Device Trolley

E-238

**DIMENSIONS (WxSxH)** | **WEIGHT**  
45 x 70 x 85 cm | 20 Kg

#### PROPERTIES

Antibacterial electrostatic powder paint  
ABS antistatik ikisi frenli dört adet teker  
Profile body  
2 small and 1 large drawer  
304 Quality 18/8 chrome-nickel alt ve üst tezgah



### Dressing Device Trolley

E-238/A

**DIMENSIONS (WxSxH)** | **WEIGHT**  
50 x 90 x 85 cm | 12 Kg

#### PROPERTIES

Antibacterial electrostatic powder paint  
ABS antistatik ikisi frenli dört adet teker  
Profile body  
ABS antibacterial workbench  
304 Quality 18/8 chrome-nickel alt tezgah  
Pushing handle



### Dressing And Device Trolley

E-238/B

**DIMENSIONS (WxSxH)** | **WEIGHT**  
45 x 70 x 85 cm | 30 Kg

#### PROPERTIES

Antibacterial electrostatic powder paint  
ABS antistatik ikisi frenli dört adet teker  
Profile body  
2 small and 1 large drawer  
304 Quality 18/8 chrome-nickel üst tezgah  
Cupboard





### Dressing Trolley

E-250

**DIMENSIONS (WxSxH)** | **WEIGHT**  
45 x 77 x 84 cm | 12 Kg

#### PROPERTIES

Antibacterial electrostatic powder paint  
ABS antistatik ikisi frenli dört adet teker  
Profile body  
Triple-decked  
Pushing handle



### Dressing Trolley

E-250/A

**DIMENSIONS (WxSxH)** | **WEIGHT**  
45 x 77 x 84 cm | 10 Kg

#### PROPERTIES

Antibacterial electrostatic powder paint  
ABS antistatik ikisi frenli dört adet teker  
Profile body  
Double-decked  
Pushing handle  
Optional basin



### Dressing Trolley

E-251

**DIMENSIONS (WxSxH)** | **WEIGHT**  
36 x 87 x 82 cm | 10 Kg

#### PROPERTIES

Antibacterial electrostatic powder paint  
ABS antistatik ikisi frenli dört adet teker  
Profile body  
29 x 24 trommel  
40 gage sink  
20 gage basin  
Pushing handle



### Dressing Trolley

E-252

**DIMENSIONS (WxSxH)** | **WEIGHT**  
45 x 77 x 84 cm | 10 Kg

#### PROPERTIES

Antibacterial electrostatic powder paint  
ABS antistatik ikisi frenli dört adet teker  
Profile body  
304 Quality 18/8 chrome-nickel üst ve alt  
tezgah  
Optional basin  
Pushing handle



### Dressing Trolley

E-252/A

**DIMENSIONS (WxSxH)** | **WEIGHT**  
50 x 70 x 85 cm | 16 Kg

#### PROPERTIES

Tamamı 304 Quality 18/8 chrome-nickel  
ABS antistatik ikisi frenli dört adet teker  
Drawer  
30 x 30 1.20 profile body



### Instrument Table

E-253

**DIMENSIONS (WxSxH)** | **WEIGHT**

A-50 x 75 x 75 cm	11 Kg
B-60 x 80 x 80 cm	15 Kg
C-70 x 85 x 85 cm	20 Kg
D-80 x 90 x 90 cm	25 Kg
E-90 x 120 x 90 cm	30 Kg

#### PROPERTIES

Tamamı 304 Quality 18/8 chrome-nickel  
ABS antistatik ikisi frenli dört adet teker  
30 x 30 1,20 mm profile body



### Dressing Trolley

E-253/A

**DIMENSIONS (WxSxH)** | **WEIGHT**  
45 x 105 x 85 cm | 20 Kg

#### PROPERTIES

Tamamı 304 Quality 18/8 chrome-nickel  
ABS antistatik ikisi frenli dört adet teker  
30x30 1,20 mm profile  
36x24 cm trommel  
2 piece 20 gage basin  
Alt ve üst tabla 1mm sac



### Dressing Trolley

E-254

**DIMENSIONS (WxSxH)** | **WEIGHT**  
60 x 80 x 90 cm | 40 Kg

#### PROPERTIES

Antibacterial electrostatic powder paint  
ABS antistatik ikisi frenli dört adet teker  
304 Quality 18/8 chrome-nickel üst tezgah  
Trommel - waste bin - sink with cover  
Four bottle holders  
Two drawers ve cupboard  
Pushing handle



### Dressing Trolley

E-254/A

**DIMENSIONS (WxSxH)** | **WEIGHT**  
60 x 115 x 90 cm | 35 Kg

#### PROPERTIES

Antibacterial electrostatic powder paint  
ABS antistatik ikisi frenli dört adet teker  
304 Quality 18/8 chrome-nickel üst tezgah  
Sink with cover  
Four bottle holders  
Two drawers, cupboard ve file holder  
Waste bag holder  
Pushing handle



### Dressing Trolley

E-254/B

**DIMENSIONS (WxSxH)** | **WEIGHT**  
45 x 80 x 85 cm | 25 Kg

#### PROPERTIES

Antibacterial electrostatic powder paint  
ABS antistatik ikisi frenli dört adet teker  
304 Quality 18/8 chrome-nickel üst tezgah  
Trommel - waste bin  
Three bottle holders  
Two drawers ve cupboard  
Pushing handle



### Dressing Trolley

E-254/C

**DIMENSIONS (WxSxH)** | **WEIGHT**  
45 x 70 x 90 cm | 30 Kg

#### PROPERTIES

Antibacterial electrostatic powder paint  
ABS antistatik ikisi frenli dört adet teker  
304 Quality 18/8 chrome-nickel üst tezgah  
Medical waste bin  
Four bottle holders  
Two drawers ve cupboard  
Pushing handle



### Dressing Trolley

E-254/D

**DIMENSIONS (WxSxH)** | **WEIGHT**  
60 x 80 x 110 cm | 42 Kg

#### PROPERTIES

Antibacterial electrostatic powder paint  
ABS antistatik ikisi frenli dört adet teker  
304 Quality 18/8 chrome-nickel üst tezgah  
Trommel - waste bin - sink with cover  
Four bottle holders  
Two drawers ve cupboard  
Serum hangers  
Monitör sehpa  
Pushing handle

## Dressing Arabası

E-254/E

**DIMENSIONS**  
60 x 80 x 150 cm

**WEIGHT**  
50 Kg

### PROPERTIES

Antibacterial electrostatic powder paint  
ABS antistatik ikisi frenli dört adet teker  
304 Quality 18/8 chrome-nickel üst tezgah  
Trommel - waste bin - sink with cover  
Four bottle holders  
Two drawers ve cupboard  
Antibakteriyel 10 adet ilaç koyma gözü  
Pushing handle



## Dressing Trolley

E-255

**DIMENSIONS**  
50 x 100 x 110 cm

**WEIGHT**  
40 Kg

### PROPERTIES

Antibacterial electrostatic powder paint  
ABS antistatik ikisi frenli dört adet teker  
ABS antibacterial workbench  
Trommel - waste bin- medical waste bin -  
infected waste box  
10 adet antibakteriyel şeffaf ilaç kutuları  
Yan tarafta dosyalık  
1 drawer  
Pushing handle



## Emergency Trolley

E-256

**DIMENSIONS**  
50 x 90 x 110 cm

**WEIGHT**  
50 Kg

### PROPERTIES

Antibacterial electrostatic powder paint  
ABS antistatik ikisi frenli dört adet teker  
ABS antibacterial workbench  
Waste bin - medical waste bin - vacuum and  
oxygen system  
10 adet antibakteriyel şeffaf ilaç kutuları  
Two drawers  
Mains plug, CPR board  
Pushing handle



## Dressing Trolley

E-256/A

**DIMENSIONS**  
50 x 90 x 110 cm

**WEIGHT**  
44 Kg

### PROPERTIES

Antibacterial electrostatic powder paint  
ABS antistatik ikisi frenli dört adet teker  
ABS antibacterial workbench  
Medical waste bin  
10 adet antibakteriyel şeffaf ilaç kutuları  
Two drawers  
Mains plug, CPR board  
Pushing handle



### Medicine and Dressing Trolley

E-257

**DIMENSIONS (WxSxH)** | **WEIGHT**  
50 x 90 x 110 cm | 47 Kg

#### PROPERTIES

Antibacterial electrostatic powder paint  
ABS antistatik ikisi frenli dört adet teker  
ABS antibacterial workbench  
File holder and waste bin  
32 adet antibakteriyel şeffaf ilaç kutuları  
Two drawers  
Pushing handle



### Medicine and Dressing Trolley

E-258

**DIMENSIONS (WxSxH)** | **WEIGHT**  
50 x 90 x 110 cm | 47 Kg

#### PROPERTIES

Antibacterial electrostatic powder paint  
ABS antistatik ikisi frenli dört adet teker  
ABS antibacterial workbench  
File holder and waste bin  
20 adet antibakteriyel şeffaf ilaç kutuları  
Three drawers  
Pushing handle



### Medicine Distribution Trolley

E-259

**DIMENSIONS (WxSxH)** | **WEIGHT**  
50 x 90 x 110 cm | 45 Kg

#### PROPERTIES

Antibacterial electrostatic powder paint  
ABS antistatik ikisi frenli dört adet teker  
ABS antibacterial workbench  
File holder and waste bin  
40 adet antibakteriyel şeffaf ilaç kutuları  
Pushing handle

## Emergency Dressing Trolley

E-260

**DIMENSIONS (WxSxH)** | **WEIGHT**  
50 x 90 x 110 cm | 55 Kg

### PROPERTIES

Antibacterial electrostatic powder paint  
ABS antistatik ikisi frenli dört adet teker  
ABS antibacterial workbench  
File holder and waste bin  
Five drawers  
Pushing handle



## Emergency Dressing Trolley

E-260/A

**DIMENSIONS (WxSxH)** | **WEIGHT**  
50 x 90 x 125 cm | 57 Kg

### PROPERTIES

Antibacterial electrostatic powder paint  
ABS antistatik ikisi frenli dört adet teker  
ABS antibacterial workbench  
File holder and waste bin  
Five drawers  
Monitör sehpası and hanger  
Pushing handle





### Commode

E-270

**DIMENSIONS (WxSxH)** | **WEIGHT**  
37 x 44 x 67 cm | 16 Kg

#### PROPERTIES

Antibacterial electrostatic powder paint  
ABS antistatik ikisi frenli dört adet teker  
Wood workbench  
Drawer and cupboard



### Commode

E-271

**DIMENSIONS (WxSxH)** | **WEIGHT**  
37 x 44 x 80 cm | 16 Kg

#### PROPERTIES

Antibacterial electrostatic powder paint  
ABS antistatik ikisi frenli dört adet teker  
Wood workbench  
Drawer and cupboard



### Dining Table

E-273

**DIMENSIONS (WxSxH)** | **WEIGHT**  
40 x 80 x 80-100 cm | 10 Kg

#### PROPERTIES

Antibacterial electrostatic powder paint  
ABS antistatik ikisi frenli dört adet teker  
Wood workbench  
Movement with damper



### Dining Table

E-273/A

**DIMENSIONS (WxSxH)** | **WEIGHT**  
40 x 80 x 80-100 cm | 10 Kg

#### PROPERTIES

Antibacterial electrostatic powder paint  
ABS antistatik ikisi frenli dört adet teker  
ABS antibacterial workbench  
Movement with damper



### Laundry Trolley

E-274

**DIMENSIONS (WxSxH)** | **WEIGHT**  
60 x 100 x 92 cm | 15 Kg

**PROPERTIES**

Antibacterial electrostatic powder paint  
ABS antistatik ikisi frenli dört adet teker  
Antibacterial PVC brenda  
Profile body  
Pushing handle



### Laundry Trolley

E-274/A

**DIMENSIONS (WxSxH)** | **WEIGHT**  
45 x 145 x 95 cm | 28 Kg

**PROPERTIES**

Antibacterial electrostatic powder paint  
ABS antistatik ikisi frenli dört adet teker  
Antibacterial PVC brenda  
Profile body  
Clean cloth shelf



### Laundry Trolley

E-274/B

**DIMENSIONS (WxSxH)** | **WEIGHT**  
45 x 110 x 95 cm | 22 Kg

**PROPERTIES**

Antibacterial electrostatic powder paint  
ABS antistatik ikisi frenli dört adet teker  
Antibacterial PVC brenda  
Profile body  
Clean cloth shelf  
Pushing handle



### Laundry Trolley

E-274/C

**DIMENSIONS (WxSxH)** | **WEIGHT**  
75 x 97 x 82 cm | 22 Kg

**PROPERTIES**

Antibacterial electrostatic powder paint  
ABS antistatik ikisi frenli dört adet teker  
Plastic 280 lt capacity  
Pushing handle



### Laundry Trolley

E-274/D

**DIMENSIONS (WxSxH)** | **WEIGHT**  
75 x 100 x 82 cm | 25 Kg

#### PROPERTIES

Antibacterial electrostatic powder paint  
ABS antistatik ikisi frenli dört adet teker  
Plastic 280 lt capacity  
Pushing handle  
Metal cover



### Laundry Trolley

E-274/E

**DIMENSIONS (WxSxH)** | **WEIGHT**  
47 x 110 x 95 cm | 28 Kg

#### PROPERTIES

Antibacterial electrostatic powder paint  
ABS antistatik ikisi frenli dört adet teker  
Antibacterial PVC brenda  
Profile body  
Covered clean cloth container  
Pushing handle



### Laundry Trolley

E-274/F

**DIMENSIONS (WxSxH)** | **WEIGHT**  
65 x 100 x 82 cm | 15 Kg

#### PROPERTIES

ABS plastic  
Antibacterial wheels



### Laundry Trolley

E-274/G

**DIMENSIONS (WxSxH)** | **WEIGHT**  
65 x 100 x 85 cm | 20 Kg

#### PROPERTIES

ABS plastic body  
Antibacterial wheels  
With covers





### Equipment Trolley

E-261

**DIMENSIONS (WxSxH)** | **WEIGHT**  
62 x 87 x 90 cm | 17 Kg

#### PROPERTIES

304 Quality 18/8 chrome-nickel  
ABS antistatik ikisi frenli dört adet teker  
Pushing handles  
Double-decked



### Equipment Trolley

E-261/A

**DIMENSIONS (WxSxH)** | **WEIGHT**  
62 x 87 x 90 cm | 20 Kg

#### PROPERTIES

304 Quality 18/8 chrome-nickel  
ABS antistatik ikisi frenli dört adet teker  
Pushing handles  
Triple-decked



### Equipment Trolley

E-261/B

**DIMENSIONS (WxSxH)** | **WEIGHT**  
55 x 85 x 90 cm | 17 Kg

#### PROPERTIES

304 Quality 18/8 chrome-nickel  
ABS antistatik ikisi frenli dört adet teker  
Pushing handles  
Depth 8 cm



### Cabinet With Stainless Drawers

E-262

**DIMENSIONS (WxSxH)** | **WEIGHT**  
50 x 80 x 85 cm | 40 Kg

#### PROPERTIES

304 Quality 18/8 chrome-nickel  
Six drawers  
ABS antistatik ikisi frenli dört adet teker



### Cabinet With Trolley

E-262/A

**DIMENSIONS (WxSxH)** | **WEIGHT**  
45x 60 x 85 cm | 30 Kg

#### PROPERTIES

304 Quality 18/8 chrome-nickel  
İki adet kilitli çekmece ve dolap  
ABS antistatik ikisi frenli dört adet teker  
Plastic waste bin  
26 cm sink



### Surgical Tool Washing Sinks

E-263

**DIMENSIONS (WxSxH)** | **WEIGHT**  
60 x 80 x 80 cm | 15 Kg

#### PROPERTIES

304 Quality 18/8 chrome-nickel  
ABS antistatik ikisi frenli dört adet teker  
Fixed shelf system  
Top sink depth: 10 cm  
Bottom sink depth: 20 cm  
Pushing handle



### Sterilization Liquid Pool

E-263/A

**DIMENSIONS (WxSxH)** | **WEIGHT**  
55 x 75 x 90 cm | 12 Kg

#### PROPERTIES

304 Quality 18/8 chrome-nickel  
ABS antistatik ikisi frenli dört adet teker  
Waste valve  
Sink depth: 30 cm  
Pushing handle



### Medical Waste Trolley

E-264

**DIMENSIONS (WxSxH)** | **WEIGHT**  
55 x 85 x 90 cm | 18 Kg

#### PROPERTIES

304 Quality 18/8 chrome-nickel  
ABS antistatik ikisi frenli dört adet teker  
Pushing handle  
Depth: 50 cm



### Material Handling Cart

E-265

**DIMENSIONS (WxSxH)** | **WEIGHT**  
60 x 80 x 95 cm | 18 Kg

#### PROPERTIES

304 Quality 18/8 chrome-nickel  
ABS antistatik ikisi frenli dört adet teker  
Platform height: 20 cm



### Material Handling Cart With a Basket

E-265/A

**DIMENSIONS (WxSxH)** | **WEIGHT**  
60 x 80 x 95 cm | 25 Kg

#### PROPERTIES

304 Quality 18/8 chrome-nickel  
ABS antistatik ikisi frenli dört adet teker  
Platform height: 20 cm  
Basket dimensions: 60 x 70 x 60 cm

## Mayo Table

E-275

**DIMENSIONS (WxSxH)** | **WEIGHT**  
45 x 65 x 87-125 cm | 7 Kg

### PROPERTIES

Antibacterial electrostatic powder paint  
ABS antistatik ikisi frenli üç adet teker  
304 Quality 18/8 chrome-nickel üst tabla  
Manual height adjustment



## Mayo Table

E-276

**DIMENSIONS (WxSxH)** | **WEIGHT**  
50 x 70 x 90-120 cm | 10 Kg

### PROPERTIES

304 Quality 18/8 chrome-nickel  
ABS antistatik ikisi frenli üç adet teker  
Manual height adjustment



## Mayo Table

E-277

**DIMENSIONS (WxSxH)** | **WEIGHT**  
50 x 70 x 85-120 cm | 22 -25 Kg  
60 x 90 x 85-120 cm

### PROPERTIES

304 Quality 18/8 chrome-nickel  
ABS antistatik ikisi frenli üç adet teker  
Hydraulic height adjustment  
Independent 360 degrees revolable top table





### Operating Room Shelf System

E-280

**DIMENSIONS (WxSxH)** | **WEIGHT**  
45 x 150 x 180 cm | 40 Kg

**PROPERTIES**

304 Quality 18/8 chrome-nickel  
Grid shelf  
Each shelf has 200 Kg carrying capacity  
Optional railing  
Unmountable system



### Basket With Shelf System

E-280/A

**DIMENSIONS (WxSxH)** | **WEIGHT**  
45 x 75 x 175 cm | 30 Kg

**PROPERTIES**

Antibacterial electrostatic powder paint  
ABS antistatik ikisi frenli dört adet teker  
Grid shelf  
Unmountable system  
Basket depth:17 cm



### Wire Basket

E-281

**DIMENSIONS (WxSxH)** | **WEIGHT**  
60 x 75 x 75 cm | 15 Kg

**PROPERTIES**

Full 304 Quality 18/8 chrome-nickel  
ABS antistatik ikisi frenli dört adet teker  
Grid shelf



### Trolley With Basket

E-281/A

**DIMENSIONS (WxSxH)** | **WEIGHT**  
45 x 85 x 90 cm | 15 Kg

**PROPERTIES**

Antibacterial electrostatic powder paint  
ABS antistatik ikisi frenli dört adet teker  
Grid shelf  
Unmountable system  
Basket depth: 25 cm

## Veterinary Operation Table

E-278

**DIMENSIONS (WxSxH)** | **WEIGHT**  
60 x 140 x 45-85 cm | 35 Kg

### PROPERTIES

304 Quality 18/8 chrome-nickel  
Column motor  
Leg or hand remote  
Waste water drain  
Eğim ayarı sağlayan Amortisör sistemi  
Ball joint bases  
Yarn attribution hooks

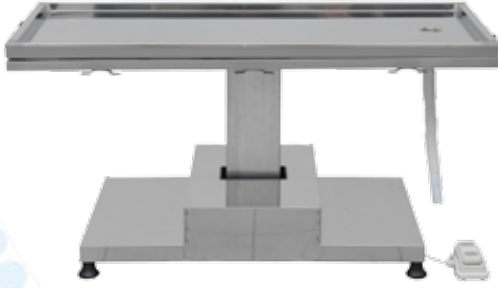

## Veterinary Examination Table

E-278/B

**DIMENSIONS (WxSxH)** | **WEIGHT**  
70 x 140 x 100 cm | 25 Kg

### PROPERTIES

304 Quality 18/8 chrome-nickel tabla  
Antibacterial electrostatic powder paint  
ABS antistatik ikisi frenli dört adet teker  
Her iki tarafa eğim ayarı  
Waste water drain  
Serum hangers  
Yarn attribution hooks





### Veterinary Examination Table

E-278/A

**DIMENSIONS (WxSxH)** | **WEIGHT**  
65 x 140 x 90 cm | 15 Kg

#### PROPERTIES

304 Quality 18/8 chrome-nickel üst tabla  
Antibacterial electrostatic powder paint  
Serum hangers



### Veterinary Stretcher

E-279/B

**DIMENSIONS (WxSxH)** | **WEIGHT**  
60 x 120 cm | 5 Kg

#### PROPERTIES

Antibacterial electrostatic powder paint  
PVC antibacterial brenda  
Sabitleme bantları



### Veterinary Stretcher

E-279/C

**DIMENSIONS (WxSxH)** | **WEIGHT**  
65 x 120 x 80cm | 10 Kg

#### PROPERTIES

Antibacterial electrostatic powder paint  
ABS antistatik ikisi frenli dört adet teker  
Removable top part  
Antibacterial stretcher brenda  
Serum hangers



### Veterinary Stretcher

E-279/D

**DIMENSIONS (WxSxH)** | **WEIGHT**  
65 x 130 x 25-100cm | 11 Kg

#### PROPERTIES

Antibacterial electrostatic powder paint  
ABS antistatik ikisi frenli dört adet teker  
Antibacterial stretcher brenda

## Veterinary Table

E-279

**DIMENSIONS (WxSxH)** | **WEIGHT**  
70 x 140 x 90 cm | 24 Kg

### PROPERTIES

304 Quality 18/8 chrome-nickel tabla  
Antibacterial electrostatic powder paint  
Her iki tarafa eğim ayarı  
Waste water drain  
Serum hangers  
İp bağlama yerleri  
Fixed leg piece



## Veterinary Operation Table

E-279/A

**DIMENSIONS (WxSxH)** | **WEIGHT**  
68 X 150 X 55-105 cm | 60 Kg

### PROPERTIES

304 Quality 18/8 chrome-nickel üst tabla  
Antibacterial electrostatic powder paint  
ABS antistatik ikisi frenli dört adet teker  
Electric motor  
Hand remote  
Top table with damper  
Top table may become a stretcher  
Waste sink: 8 cm  
Serum hangers





### Veterinary Operation Table

E-279/P

**DIMENSIONS (WxSxH)** | **WEIGHT**  
75 x 150 x 55-105 cm | 65 Kg

#### PROPERTIES

304 Quality 18/8 chrome-nickel pres baskılı üst tabla  
Antibacterial electrostatic powder paint  
ABS antistatik ikisi frenli dört adet teker  
Double electric motor  
Hand remote  
Motor ile ayarlanabilir üst tabla  
Waste sink: 8 cm  
Waste water drain  
Top table may become a stretcher

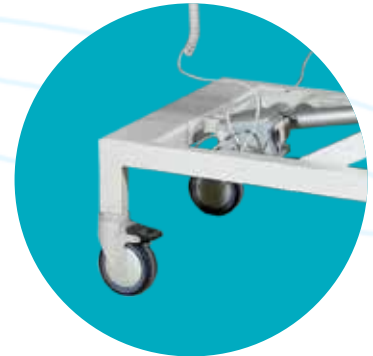
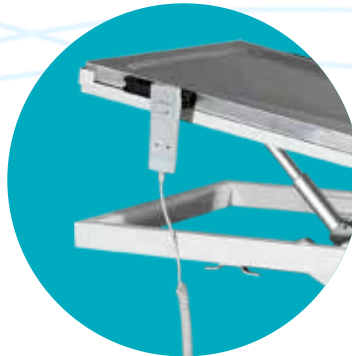





### Baby Bed

E-282

**DIMENSIONS (WxSxH)** | **WEIGHT**  
45 x 75 x 95 cm | 9 Kg

#### PROPERTIES

Antibacterial electrostatic powder paint  
ABS antistatik ikisi frenli dört adet teker  
Antibacterial plexiglas  
Waterproof antibacterial mattress



### Baby Bed

E-282/A

**DIMENSIONS (WxSxH)** | **WEIGHT**  
45 x 75 x 93 cm | 9,5 Kg

#### PROPERTIES

Antibacterial electrostatic powder paint  
ABS antistatik ikisi frenli dört adet teker  
Antibacterial plexiglas  
Waterproof antibacterial mattress  
Shelf



### Baby Bed

E-282/B

**DIMENSIONS (WxSxH)** | **WEIGHT**  
45 x 75 x 93 cm | 9 Kg

#### PROPERTIES

Antibacterial electrostatic powder paint  
ABS antistatik ikisi frenli dört adet teker  
Antibacterial plexiglas  
Waterproof antibacterial mattress  
Baş kaldırma hareketi



### Baby Bed

E-283

**DIMENSIONS (WxSxH)** | **WEIGHT**  
45 x 74 x 90 cm | 7 Kg

#### PROPERTIES

Antibacterial electrostatic powder paint  
ABS antistatik ikisi frenli dört adet teker  
Antibacterial plexiglas  
Waterproof antibacterial mattress  
Basket  
Pushing handle



### Baby Bed

E-283/A

**DIMENSIONS (WxSxH)** | **WEIGHT**  
45 x 75 x 80 cm | 10 Kg

#### PROPERTIES

Antibacterial electrostatic powder paint  
ABS antistatik ikisi frenli dört adet teker  
Antibacterial plexiglas  
Waterproof antibacterial mattress  
Drawer  
Pushing handle



### Baby Bed

E-284

**DIMENSIONS (WxSxH)** | **WEIGHT**  
45 x 76 x 92 cm | 23 Kg

#### PROPERTIES

Antibacterial electrostatic powder paint  
ABS antistatik ikisi frenli dört adet teker  
Antibacterial plexiglas  
Waterproof antibacterial mattress  
Drawer and cupboard



### Baby Changing Table

E-284/A

**DIMENSIONS (WxSxH)** | **WEIGHT**  
50 x 85 x 105 cm | 15 Kg

#### PROPERTIES

Antibacterial electrostatic powder paint  
Fixed stand  
Antibacterial upholstery



### Baby Changing Table

E-284/B

**DIMENSIONS (WxSxH)** | **WEIGHT**  
85 x 50 x 105 cm | 20 Kg

#### PROPERTIES

Antibacterial electrostatic powder paint  
Antibacterial upholstery  
Alt kısım malzeme koyma rafı

## Screen

E-285

**DIMENSIONS (WxSxH)** | **WEIGHT**  
40 x 80 x 170 cm | 10 Kg

### PROPERTIES

Antibacterial electrostatic powder paint  
ABS antistatic wheels  
Open length 240 cm  
White cloth curtain  
Folding body  
Optional PVC brenda



## Screen

E-285/A

**DIMENSIONS (WxSxH)** | **WEIGHT**  
40 x 80 x 170 cm | 10 Kg

### PROPERTIES

Nickel plating  
ABS antistatic wheels  
Open length 240 cm  
Folding body  
PVC brenda



## Screen

E-286

**DIMENSIONS (WxSxH)** | **WEIGHT**  
45 x 85 x 177 cm | 23 Kg

### PROPERTIES

Full wooden body  
ABS antistatic wheels  
Open length 250 cm  
Folding body  
Leather screens





### Serum Hanger

E-287

**DIMENSIONS (WxSxH)** | **WEIGHT**  
50 x 50 x 105-187cm | 3 Kg

#### PROPERTIES

Antibacterial electrostatic powder paint  
ABS antistatik ikisi frenli dört adet teker  
Nickel plated hanger part



### Serum Hanger

E-287/A

**DIMENSIONS (WxSxH)** | **WEIGHT**  
50 x 50 x 105-190cm | 3,5 Kg

#### PROPERTIES

Antibacterial electrostatic powder paint  
ABS antistatik ikisi frenli beş adet teker  
Nickel plated hanger part  
Optional two or four hook



### Serum Hanger

E-287/B

**DIMENSIONS (WxSxH)** | **WEIGHT**  
60 x 60 x 105-190cm | 3,5 Kg

#### PROPERTIES

Antibacterial electrostatic powder paint  
ABS antistatik ikisi frenli beş adet teker  
Nickel plated hanger part  
Optional two or four hook  
Plastic ABS stand

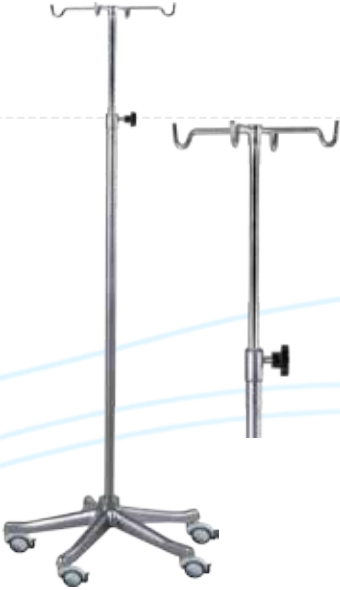

### Serum Hanger

E-288

**DIMENSIONS (WxSxH)** | **WEIGHT**  
60 x 60 x 130-220cm | 9 Kg

#### PROPERTIES

Antibacterial electrostatic powder paint  
ABS antistatik ikisi frenli beş adet teker  
Nickel plated hanger part  
Four hook  
Casting stand

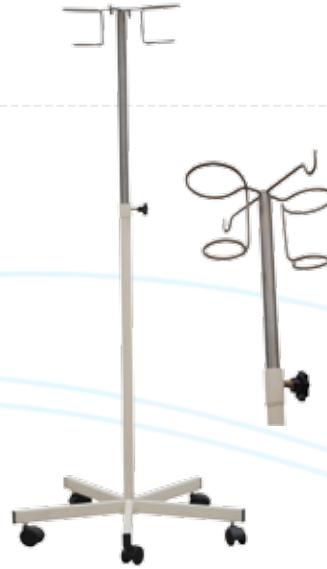

### Serum Hanger

E-288/A

**DIMENSIONS (WxSxH)** | **WEIGHT**  
60 x 60 x 130-210cm | 4 Kg

#### PROPERTIES

Antibacterial electrostatic powder paint  
ABS antistatik ikisi frenli beş adet teker  
304 Quality 18/8 chrome-nickel askı bölümü  
Serum bottle hangers



### Serum Hanger

E-289

**DIMENSIONS (WxSxH)** | **WEIGHT**  
55 x 55 x 115-210cm | 5 Kg

#### PROPERTIES

304 Quality 18/8 chrome-nickel gövde  
ABS antistatik ikisi frenli beş adet teker  
Four hook  
Suitable for carrying infusion pump

## Serum Hanger

E-289/A

**DIMENSIONS (WxSxH)** | **WEIGHT**  
60 x 60 x 125-210cm | 6 Kg

### PROPERTIES

Tamamı 304 Quality 18/8 chrome-nickel gövde  
ABS antistatik ikisi frenli beş adet teker  
Four hangers



## Serum Hanger

E-289/B

**DIMENSIONS (WxSxH)** | **WEIGHT**  
60 x 60 x 115-210cm | 6 Kg

### PROPERTIES

304 Quality 18/8 chrome-nickel gövde  
ABS antistatik ikisi frenli beş adet teker  
Four hangers  
Suitable for carrying infusion pump  
Nikelaj beş ayak



## Lead Apron Hanger Trolley

E-289/C

**DIMENSIONS (WxSxH)** | **WEIGHT**  
80 x 56 x 173 cm | 15 Kg

### PROPERTIES

Antibacterial electrostatic powder paint  
ABS antistatik ikisi frenli dört adet teker  
Six apron hangers





Reflector

E-290

**DIMENSIONS (WxSxH)** | **WEIGHT**  
50 x 50 x 120-160cm | 3 Kg

**PROPERTIES**

Antibacterial electrostatic powder paint  
ABS antistatik ikisi frenli dört adet teker  
With normal lamp  
Optional LED lamp



Reflector

E-291

**DIMENSIONS (WxSxH)** | **WEIGHT**  
50 x 50 x 120-170cm | 3 Kg

**PROPERTIES**

Antibacterial electrostatic powder paint  
ABS antistatik ikisi frenli dört adet teker  
Spotlight  
Optional LED lamp



Reflector

E-291/A

**DIMENSIONS (WxSxH)** | **WEIGHT**  
60 x 60 x 200 cm | 5 Kg

**PROPERTIES**

Antibacterial electrostatic powder paint  
ABS antistatik ikisi frenli beş adet teker  
Led lamp and zoom setting  
Odaklı aydınlatma  
Lamp diameter 3 cm  
Spiral body



Reflector

E-292

**DIMENSIONS (WxSxH)** | **WEIGHT**  
60 x 60 x 200 cm | 5 Kg

**PROPERTIES**

Antibacterial electrostatic powder paint  
ABS antistatik ikisi frenli beş adet teker  
Spotlight  
Lamp diameter 8 cm  
Spiral body



Illuminated Loop

E-292/B

**DIMENSIONS (WxSxH)** | **WEIGHT**  
50 x 50 x 155 cm | 8 Kg

**PROPERTIES**

Antibacterial electrostatic powder paint  
ABS antistatik ikisi frenli beş adet teker  
Casting stand  
Beş büyütmeli mercek  
80 pieces 8 w led lamp  
12 cm lens diameter  
White light



## Escape

E-293

**DIMENSIONS (WxSxH)** | **WEIGHT**  
46 x 40 x 40 cm | 6 Kg

### PROPERTIES

Full 304 Quality 18/8 chrome-nickel  
First step dimension: 20 cm  
30x30 1,20 mm profile base



## Escape

E-293/A

**DIMENSIONS (WxSxH)** | **WEIGHT**  
22 x 40 x 20 cm | 3 Kg

### PROPERTIES

Tamami 304 Quality 18/8 chrome-nickel  
30x30 1,20 mm profile base



## Escape

E-293/B

**DIMENSIONS (WxSxH)** | **WEIGHT**  
25 x 60 x 13 cm | 3 Kg

### PROPERTIES

Tamami 304 Quality 18/8 chrome-nickel  
30x30 1,20 mm profile base  
Zemin dengesini saglayan ayarlanabilir rotill ayaklar

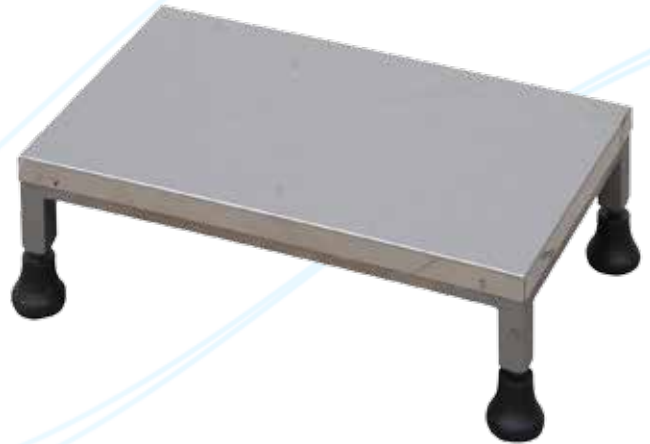



## Escape

E-294

**DIMENSIONS (WxSxH)** | **WEIGHT**  
43 x 40 x 43 cm | 4,70 Kg

### PROPERTIES

Antibacterial electrostatic powder paint  
First step dimension: 20 cm  
Wooden steps  
25x1,20 metal pipe



## Escape

E-294/A

**DIMENSIONS (WxSxH)** | **WEIGHT**  
20 x 40 x 22,5 cm | 2 Kg

### PROPERTIES

Antibacterial electrostatic powder paint  
Wooden step  
25x1,20 metal pipe



## Escape

E-295

**DIMENSIONS (WxSxH)** | **WEIGHT**  
43 x 40 x 43 cm | 3,5 Kg

### PROPERTIES

Full wood-work  
First step dimension: 20 cm



## Escape

E-295/A

**DIMENSIONS (WxSxH)** | **WEIGHT**  
40 x 30 x 85 cm | 4 Kg

### PROPERTIES

Antibacterial electrostatic powder paint  
Step dimension: 22 cm  
El tutma yeri





Port Bowl

E-297

**DIMENSIONS (WxSxH)** | **WEIGHT**  
60 x 60 x 90 cm | 4 Kg

**PROPERTIES**

Antibacterial electrostatic powder paint  
ABS antistatik ikisi frenli dört adet teker  
304 Quality 18/8 chrome-nickel 30 cm basin  
Basin depth: 16 cm  
Pushing handle



Port Bowl

E-297/A

**DIMENSIONS (WxSxH)** | **WEIGHT**  
34 x 43 x 75 cm | 5 Kg

**PROPERTIES**

Antibacterial electrostatic powder paint  
ABS antistatik ikisi frenli dört adet teker  
304 Quality 18/8 chrome-nickel 30 cm basin  
Basin depth: 7 cm  
Tool shelf



Port Bowl

E-297/B

**DIMENSIONS (WxSxH)** | **WEIGHT**  
60 x 60 x 90 cm | 5 Kg

**PROPERTIES**

304 Quality 18/8 chrome-nickel  
ABS antistatik ikisi frenli beş adet teker  
304 Quality 18/8 chrome-nickel 30 cm basin  
Basin depth: 16 cm  
Pushing handle

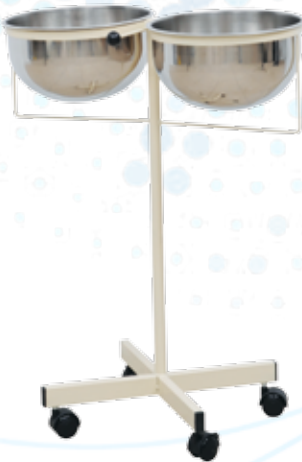

Port Bowl

E-298

**DIMENSIONS (WxSxH)** | **WEIGHT**  
60 x 65 x 90 cm | 5,5 Kg

**PROPERTIES**

Antibacterial electrostatic powder paint  
ABS antistatik ikisi frenli dört adet teker  
Two pieces 304 Quality 18/8 chrome-nickel 30 cm basin  
Basin depth: 16 cm  
Pushing handle



Port Bowl

E-298/A

**DIMENSIONS (WxSxH)** | **WEIGHT**  
60 x 65 x 90 cm | 6,5 Kg

**PROPERTIES**

304 Quality 18/8 chrome-nickel  
ABS antistatik ikisi frenli beş adet teker  
Two pieces 304 Quality 18/8 chrome-nickel 30 cm basin  
Basin depth: 16 cm  
Pushing handle



10 lt



5 lt



### Tube Carrying Trolley

E-299

**DIMENSIONS (WxSxH)** 25 x 30 x 96 cm | **WEIGHT** 2,5 Kg

**PROPERTIES**  
Antibacterial electrostatic powder paint  
ABS antistatic two wheels  
Tube protection chain  
Suitable for carrying 10 Lt tubes  
Pushing handle  
5 lt tüp taşıma için bilgi alınız

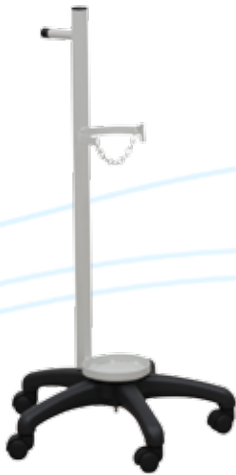

### Tube Carrying Trolley

E-299/A

**DIMENSIONS (WxSxH)** 60 x 60 x 105 cm | **WEIGHT** 3 Kg

**PROPERTIES**  
Antibacterial electrostatic powder paint  
ABS antistatic five wheels  
Suitable for carrying 10 Lt tubes  
Tube protection chain  
Pushing handle

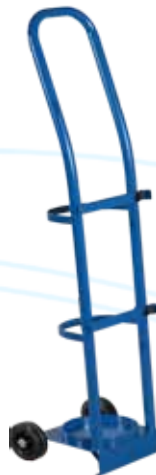

### Tube Carrying Trolley

E-299/B

**DIMENSIONS (WxSxH)** 50 x 50 x 163 cm | **WEIGHT** 12 Kg

**PROPERTIES**  
Antibacterial electrostatic powder paint  
ABS antistatic two wheels  
Suitable for carrying 5 Lt or 10 Lt tubes  
Pushing handle

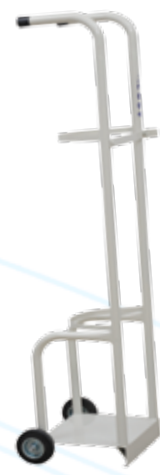

### Tube Carrying Trolley

E-300

**DIMENSIONS (WxSxH)** 36 x 45 x 160 cm | **WEIGHT** 8 Kg

**PROPERTIES**  
Antibacterial electrostatic powder paint  
ABS antistatic two wheels  
Suitable for carrying 40 Lt tubes  
Pushing handle



Stool

E-301

**DIMENSIONS (WxSxH)** | **WEIGHT**  
40 x 40 x 50-63 cm | 4 Kg

**PROPERTIES**  
Antibacterial electrostatic powder paint  
Milli sistem ile çevirerek yükselme  
Seat diameter 35 cm  
Antibacterial upholstery



Stool

E-302

**DIMENSIONS (WxSxH)** | **WEIGHT**  
50 x 50 x 50-63 cm | 4,5 Kg

**PROPERTIES**  
Antibacterial electrostatic powder paint  
Milli sistem ile çevirerek yükselme  
Seat diameter 35 cm  
Antibacterial upholstery  
ABS antistatic four wheels



Stool

E-303

**DIMENSIONS (WxSxH)** | **WEIGHT**  
60 x 60 x 45-57 cm | 5 Kg

**PROPERTIES**  
Hydraulic height adjustment  
Antibacterial upholstery  
ABS antistatic five wheels  
Plastik ayakça



Stool

E-304

**DIMENSIONS (WxSxH)** | **WEIGHT**  
60 x 60 x 88-100 cm | 8 Kg

**PROPERTIES**  
Antibacterial electrostatic powder paint  
Hydraulic height adjustment  
Antibacterial upholstery  
ABS antistatic five wheels



Stool

E-304/A

**DIMENSIONS (WxSxH)** | **WEIGHT**  
60 x 60 x 50-70 cm | 9 Kg

**PROPERTIES**  
Nikelajlı metal ayak  
Hydraulic height adjustment  
Antibacterial upholstery  
ABS antistatic five wheels  
Polyurethane backrest  
Seat diameter 35 cm



Stool

E-304/B

**DIMENSIONS (WxSxH)** | **WEIGHT**  
60 x 60 x 45-57 cm | 9 Kg

**PROPERTIES**  
Antibacterial electrostatic powder paint  
Hydraulic height adjustment  
Antibacterial upholstery  
ABS antistatic five wheels



**Patient Toilet Seat**

E-305

**WEIGHT**  
2 Kg

**PROPERTIES**

Toilet seat  
Height adjustment  
Katlanabilir özellik



**Walker**

E-306

**WEIGHT**  
2 Kg

**PROPERTIES**

Katlanabilir özellik  
Height adjustment



**Crutch**

E-306/A

**DIMENSIONS (WxSxH)**  
100 x 200 x 45 cm

**WEIGHT**  
1 Kg

**PROPERTIES**

Height adjustment  
Wrist grip



**Tripot Cane**

E-306/B

**WEIGHT**  
1 Kg

**PROPERTIES**

Height adjustment  
Tripod



**Crutch**

E-306/C

**WEIGHT**  
2 Kg

**PROPERTIES**

Height adjustment



### Wheelchair Patients

E-307

**DIMENSIONS (WxSxH)** | **WEIGHT**  
67 x 105 x 85 cm | 17 Kg

#### PROPERTIES

Solid wheels  
Aluminum rear wheel rims  
Metal food pedal  
Antibacterial upholstery  
Seat height: 50 cm  
Seat dimensions: 44 x 44 cm



### Wheelchair Patients

E-307/A

**DIMENSIONS (WxSxH)** | **WEIGHT**  
67 x 105 x 90 cm | 20 Kg

#### PROPERTIES

Solid wheels  
Aluminum rear wheel rims  
Metal food pedal  
Antibacterial upholstery  
Raising pedal  
Seat height: 50 cm  
Seat dimensions: 45 x 40 cm



### Wheelchair Patients

E-308

**DIMENSIONS (WxSxH)** | **WEIGHT**  
67 x 105 x 90 cm | 20 Kg

#### PROPERTIES

Solid wheels  
Aluminum rear wheel rims  
Metal food pedal  
Antibacterial upholstery  
Seat height: 50 cm  
Seat dimensions: 45 x 40 cm  
Bedpan fixture



### Wheelchair Patients

E-309

**DIMENSIONS (WxSxH)** | **WEIGHT**  
55 x 77 x 95 cm | 14 Kg

#### PROPERTIES

Plastic food pedal  
Antibacterial upholstery  
Katlanabilir özellik  
Metal aksamlar nikelaj  
Bedpan fixture



### Wheelchair Patients

E-310

**DIMENSIONS (WxSxH)** | **WEIGHT**  
75 x 105 x 120 cm | 18 Kg

#### PROPERTIES

Solid wheels  
Antibacterial upholstery  
Antibakteriyel elektrostatik boya  
Seat dimensions: 50 x 45 cm  
Serum hangers



### Patient Bath Trolley

E-311

**DIMENSIONS (WxSxH)** | **WEIGHT**  
55 x 85 x 95 cm | 15 Kg

#### PROPERTIES

Chrome-nickel plated  
Bedpan fixture  
Leg rest apparatus can be removed  
Seat height: 52 cm  
Seat dimensions: 43 x 43 cm



## Negatoscope

E-320

### DIMENSIONS (WxSxH)

- A) 11 x 42 x 52 cm
- B) 11 x 76 x 52 cm
- C) 11 x 120 x 52 cm
- D) 11 x 150 x 52 cm

### WEIGHT

5-8-14-20 Kg

### PROPERTIES

Antibacterial electrostatic powder paint  
Profile body  
Automatic electronic starter  
With fluorescent lamp



## Negatoscope

E-320/E

### DIMENSIONS (WxSxH)

- E) 2,4 x 45 x 52 cm
- F) 2,4 x 84 x 52 cm
- G) 2,4 x 115 x 52 cm
- H) 2,4 x 150 x 52 cm

### WEIGHT

5-7-10-15 Kg

### PROPERTIES

Led lamp  
50.000 saat lamba ömrü  
Non-flickering light brightness



## Eye Scale

E-321

### DIMENSIONS (WxSxH)

10 x 25 x 72 cm

### WEIGHT

4 Kg

### PROPERTIES

Antibacterial electrostatic powder paint  
Scaled letters  
Automatic electronic starter  
With fluorescent lamp



### Waste Bin

<b>DIMENSIONS (WxSxH)</b>	<b>WEIGHT</b>	<b>CAPACITY</b>
56 x 49 x 96 cm	11 Kg	120 lt

#### PROPERTIES

Plastic waste bin  
Green - Orange - Grey  
Wheel  
Demonte olup iç içe taşınabilme imkanı  
60 Kg or 120 lt capacity

E-327



### Medical Waste Bin

<b>DIMENSIONS (DxH)</b>	<b>WEIGHT</b>	<b>CAPACITY</b>
41 x 50 cm	3 Kg	40 lt

#### PROPERTIES

Plastic medical waste bin  
Opening pedal

E-327/A



### Recycling Bins

<b>DIMENSIONS (DxH)</b>	<b>WEIGHT</b>	<b>CAPACITY</b>
40 x 80 cm	12 Kg	100 lt

#### PROPERTIES

304 Quality 18/8 chrome-nickel cover  
Poşet tutucu tel  
Recycling  
100 lt capacity  
Plastic

E-327/B



### Medical Waste Bin

<b>DIMENSIONS (WxSxH)</b>	<b>WEIGHT</b>	<b>CAPACITY</b>
36 x 36 x 65 cm	7,70 Kg	45 lt

#### PROPERTIES

Profile body  
Zemin dengesini sağlayacak rotill ayaklar  
Antibacterial electrostatic powder paint

E-328



### Medical Waste Bin

E-328/A

<b>DIMENSIONS (WxSxH)</b>	<b>WEIGHT</b>	<b>CAPACITY</b>
30 x 30 x 85 cm	2 Kg	3 lt / 5 lt

#### PROPERTIES

Antibacterial electrostatic powder paint  
ABS antistatik ikisi frenli dört adet teker  
Can hold Sharp box with 3-5 lt volume



### Waste Trolley

E-328/B

<b>DIMENSIONS (WxSxH)</b>	<b>WEIGHT</b>	<b>CAPACITY</b>
50 x 70 x 100 cm	11 Kg	100 lt

#### PROPERTIES

Antibacterial electrostatic powder paint  
Opening pedal  
Two wheels  
Çekme sapı



### Medical Waste Bin

E-329

<b>DIMENSIONS (DxH)</b>	<b>WEIGHT</b>	<b>CAPACITY</b>
35 x 38 cm	6 Kg	35 lt

#### PROPERTIES

304 Quality 18/8 chrome-nickel  
For operating room  
20 lt iç hacim  
Taşıma sapı ve kapaklı  
ABS antistatic wheels



### Medical Waste Bin

E-329/B

<b>DIMENSIONS (DxH)</b>	<b>WEIGHT</b>	<b>CAPACITY</b>
40 x 50 cm	7 Kg	50 lt

#### PROPERTIES

304 Quality 18/8 chrome-nickel  
Poşet sıkıştırma aparatı  
Pedal  
Hareket ettirmek için tekerlek sistemi







### Patinet Follow-Up Chart

**E-324**

**DIMENSIONS (WxS)**  
24 x 33 cm

**WEIGHT**  
0,5 Kg

**PROPERTIES**  
Aluminium body  
Without cover



### Nail Brush Box

**E-325**

**DIMENSIONS (WxSxH)**  
10 x 25 x 30 cm

**WEIGHT**  
1,5 Kg

**PROPERTIES**  
304 Quality 18/8 chrome-nickel body  
20-brush capacity  
May take two sided brush  
Wall-mounted



### Nail Brush Box

**E-326**

**DIMENSIONS (WxSxH)**  
9 x 14 x 50 cm

**WEIGHT**  
1 Kg

**PROPERTIES**  
304 Quality 18/8 chrome-nickel body  
With cover  
18-brush capacity  
Wall-mounted



### Liquid Soap Dispenser

**E-326/A**

**DIMENSIONS (WxSxH)**  
10 x 25 x 30 cm

**WEIGHT**  
1 Kg

**PROPERTIES**  
Plastic 1 lt soap storage  
Leg pump  
Wall-mounted



### Combi Paper Towel Holder

**E-326/B**

**DIMENSIONS (WxSxH)**  
15 x 35 x 100 cm

**WEIGHT**  
4 Kg

**PROPERTIES**  
304 Quality 18/8 chrome-nickel  
400 paper towel holders  
23 lt waste bin capacity  
Wall-mounted



### Waste Bin

**E-330**

**DIMENSIONS (DxH)**  
27,5 x 44 cm

**WEIGHT**  
1,5 Kg

**CAPACITY**  
20 lt

**PROPERTIES**  
304 Quality 18/8 chrome-nickel  
Leg pump  
18 lt capacity  
Plastic inside bucket



### Trommel

E-340

#### DIMENSIONS (DxH)

- A) 15 x 19 cm
- B) 19 x 19 cm
- C) 24 x 24 cm
- D) 29 x 24 cm
- E) 32 x 24 cm
- F) 36 x 24 cm
- G) 39 x 24 cm

#### WEIGHT

1-6 Kg

#### PROPERTIES

304 Quality 18/8 chrome-nickel  
For sterilization purposes



### Tool Box

E-342

#### DIMENSIONS (WxSxH)

- A) 12 x 22 x 6 cm
- B) 14 x 28 x 7 cm
- C) 16 x 34 x 8 cm
- D) 18 x 40 x 9 cm
- E) 20 x 50 x 10 cm

#### PROPERTIES

304 Quality 18/8 chrome-nickel  
With cover  
For sterilization purposes  
Lock system



### Bowl With Cover

E-343

#### DIMENSIONS (WxSxH)

- A) 18 x 28 x 4 cm
- B) 23 x 32 x 5 cm

#### WEIGHT

1-1,5 Kg

#### PROPERTIES

304 Quality 18/8 chrome-nickel  
With cover  
For sterilization purposes



### Bowl Without Cover

E-344

#### DIMENSIONS (WxSxH)

27 x 43 x 4 cm

#### WEIGHT

0,5 Kg

#### PROPERTIES

304 Quality 18/8 chrome-nickel  
Without cover  
For sterilization purposes



### Deep Bowl Cover

E-345

#### DIMENSIONS (WxSxH)

28 x 38 x 8 cm

#### WEIGHT

1 Kg

#### PROPERTIES

304 Quality 18/8 chrome-nickel  
Without cover  
For sterilization purposes



### Cotton Box

E-346

#### DIMENSIONS (DxH)

8 x 14 cm

#### WEIGHT

0,3 Kg

#### PROPERTIES

304 Quality 18/8 chrome-nickel  
Without cover  
For sterilization purposes



Basin

E-347

**DIMENSIONS (WxS)**

- A) 10 x 3,5 cm
- B) 20 x 5 cm
- C) 30 x 7 cm

**CAPACITY**

- 250 ml
- 1 lt
- 4 lt

**PROPERTIES**

304 Quality 18/8 chrome-nickel  
For sterilization purposes



Basin

E-347/D

**DIMENSIONS (WxS)**

30 x 16 cm

**WEIGHT**

1 Kg

**PROPERTIES**

304 Quality 18/8 chrome-nickel  
For sterilization purposes



Kidney Shaped Bowl

E-348

**DIMENSIONS (WxSxH)**

- A) 12,5 x 25,5 x 3,5 cm
- B) 14,5 x 30,4 x 4 cm

**WEIGHT**

0,5 Kg

**PROPERTIES**

304 Quality 18/8 chrome-nickel  
For sterilization purposes



One Liter Holder

E-349

**DIMENSIONS (WxSxH)**

10 x 15 x 19 cm

**WEIGHT**

1 Kg

**CAPACITY**

1 lt

**PROPERTIES**

304 Quality 18/8 chrome-nickel  
1 lt capacity  
For sterilization purposes



Container

E-350/A

**DIMENSIONS**

- 14 x 30 x 5 cm
- 14 x 30 x 10 cm
- 14 x 30 x 15 cm



Container

E-351

**DIMENSIONS**

- 28 x 28 x 10 cm
- 28 x 28 x 13 cm
- 28 x 28 x 15 cm
- 46 x 28 x 10 cm
- 46 x 28 x 15 cm



### Backboard

**DIMENSIONS (WxSxH)** | **WEIGHT**  
42 x 185 x 5 cm | 5,5 Kg

**PROPERTIES**  
250 Kg carrying capacity  
Transparent to X-Rays  
ABS antibacterial plastic  
Floats on water  
Fireproof

S-505



### Spider Belt System

**PROPERTIES**  
Designed for the backbone board

S-505/A



### Scoop Stretcher

**DIMENSIONS (WxSxH)** | **WEIGHT**  
43 x 166-200 x 7 cm | 10 Kg

**PROPERTIES**  
170 Kg carrying capacity  
Splits into two Aluminum body three belts for fixing the injured person  
Adjustable length

S-506



### Combination Stretcher

**DIMENSIONS (WxSxH)** | **WEIGHT**  
50 x 187 x 20 cm | 12 Kg

**PROPERTIES**  
250 Kg carrying capacity  
Chair size: 35 cm  
Designed to transport injured person via the stairs  
Antibacterial brenda

S-507



### Pole Stretcher

S-508

**DIMENSIONS (WxSxH)** | **WEIGHT**  
55 x 210 x 16 cm | 5,2 Kg

#### PROPERTIES

Boydan ikiye katlanan pratik sedye  
Hafif alařım özel alüminyum řasi  
Alevlenmeye, sürtünmeye ve yırtılmaya mukavemetli  
Two belts for fixing the injured person  
Katlı vaziyette yükseklik 105 cm



### Pole Stretcher

S-508/A

**DIMENSIONS (WxSxH)** | **WEIGHT**  
55 x 210 x 13 cm | 6,2 Kg

#### PROPERTIES

Boydan ve enden ikiye katlanan pratik sedye  
Hafif alařım özel alüminyum řasi  
Alevlenmeye, sürtünmeye ve yırtılmaya mukavemetli  
Two belts for fixing the injured person  
Katlı vaziyette yükseklik 105 cm  
Katlı vaziyette boyutlar: 10 x 105 x 16 cm

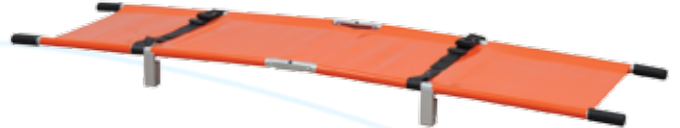

### Vacuum Stretcher

S-509

**DIMENSIONS (WxSxH)** | **WEIGHT**  
107 x 200 x 6 cm | 6,5 Kg

#### PROPERTIES

150 Kg carrying capacity  
Twelve handle systems  
Pump system for the vacuum  
Four belts for fixing the injured person  
PVC antibacterial material



### Plastic Basket Stretcher

S-509/A

**DIMENSIONS (WxSxH)** | **WEIGHT**  
61 x 216 x 17 cm | 15 Kg

#### PROPERTIES

Four belts for fixing the injured person  
Sedye zemininde kaymaz siyah EVA malzeme  
Plastik material  
Twelve handle systems



### Air Splint Set

S-510

#### PROPERTIES

Alt ve üst ekstremitte kırıkları için  
Six-piece set  
Ayak bileği, ayak bileği ve uzun bacak, kısa bacak, uzun bacak, el bileği ve kısa ön kol, el bileği ve uzun kol  
Transparent to X-Rays



### Vacuum Splint Set

S-510/A

#### PROPERTIES

Large : 108 cm x 67 cm  
Medium : 74 cm x 61 cm  
Small : 54 cm x 33 cm  
Transparent to X-Rays  
Vacuum pump  
Three-piece kit



### Emergency Extrication Set

S-511

#### PROPERTIES

Transparent to X-Rays  
Wide jaw support  
Foam pad  
HDPE Material  
Tracheal gap  
Four-piece kit



### Ring Cutting Scissors

S-512

#### PROPERTIES

304 Quality 18/8 chrome-nickel



### Ked Extrication Device

E-513

#### PROPERTIES

Baş tespit bantları  
Carrying bag  
Transparent to X-Rays  
Designed to fix the spine



## Emergency Case

S-514

**DIMENSIONS (WxSxH)** | **WEIGHT**  
35 x 45 x 16 cm | 2 Kg

### PROPERTIES

Laryngoskop set  
Steteskoplu tansiyon aleti  
Cerrahi set: Pens-Pensez-Bisturi sapı-Portegü-Makas  
PVC ambu seti  
Otomatik turnike  
Entibasyon tüpleri  
Airway  
Aluminum case



## Emergency Case

S-514/B

**DIMENSIONS (WxSxH)** | **WEIGHT**  
35 x 45 x 16 cm | 3 Kg

### PROPERTIES

Laryngoskop set  
Cerrahi set: Pens-Pensez-Bisturi sapı-Portegü-Makas  
PVC ambu seti  
Otomatik turnike  
Entibasyon tüpleri  
Airway  
1 lt oksijen tüpü ve manometresi



## Accordeon Case

S-514/A

**DIMENSIONS (WxSxH)** | **WEIGHT**  
A) 23 x 36 x 25 cm | 1 kg  
B) 23 x 45 x 32 cm

### PROPERTIES

Aluminum case  
Covers open from sides  
İç kısımda bölmeler  
Sünger iç taban döşeme





### Plastic Case

S-514/C

**DIMENSIONS (WxSxH)** | **WEIGHT**  
30 x 40 x 15 cm | 1 Kg

**PROPERTIES**  
ABS plastic material  
Four-compartment section  
Wall mount fixture



### Traume Bag

S-514/D

**DIMENSIONS (WxSxH)** | **WEIGHT**  
30 x 50 x 30 cm | 1 Kg

**PROPERTIES**  
Possible to carry at hand  
Wide reflector band  
Waterproof



### Aluminium Case

S-514/E

**DIMENSIONS (WxS)**  
35 x 45 x 16 cm

**PROPERTIES**  
Aluminium body  
İç kısımda bölmeler  
Sünger iç taban döşeme  
Kilit sistemi



### Fire Blanket

S-514/F

**DIMENSIONS (WxS)**  
210 x 160 cm

**PROPERTIES**  
Used for extinguishing flames resist up to 650 degrees of heat



### Baby Scale

S-516

#### PROPERTIES

Plastic body  
20 Kg carrying capacity  
Digital  
Battery  
Wait mode  
5 gr accuracy



### Baby Scale

S-516/A

#### PROPERTIES

Plastic body  
20 Kg carrying capacity  
Digital  
Battery  
Wait mode  
5-10 gr accuracy  
35-80 cm baby length measure



### Baby Scale

S-516/D

#### PROPERTIES

Plastic body  
20 Kg carrying capacity  
Digital  
Battery  
Wait mode  
10-20 gr accuracy  
Ability to remove the scale and weigh standing

## Scale

S-517

### PROPERTIES

Antibacterial electrostatic powder paint  
Metal body  
200 Kg carrying capacity  
Telescopic height measuring  
Mechanical measurement



## Scale

S-517/A

### PROPERTIES

Antibacterial electrostatic powder paint  
Metal body  
160 Kg carrying capacity  
Telescopic height measuring  
Mechanical measurement

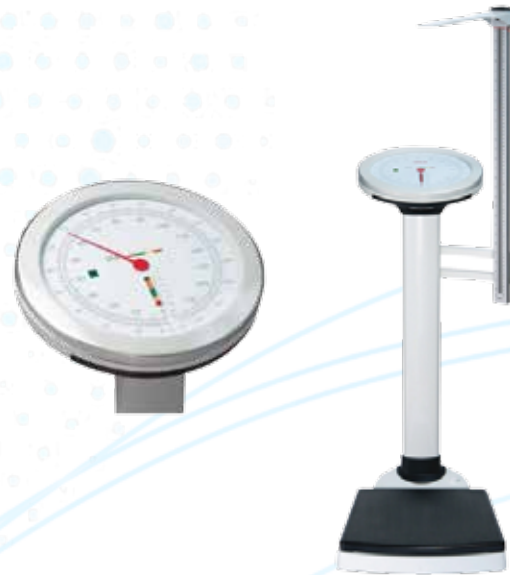

## Electronic Scale

S-518

### PROPERTIES

Antibacterial electrostatic powder paint  
Metal body  
200 Kg carrying capacity  
60-210 cm aluminum height meter  
Telescopic height measuring  
Mechanical measurement





### Baby Height Meter

S-519

**PROPERTIES**  
Wooden body  
100 cm measuring  
1-5 mm accuracy  
For babies



### Height Meter

S-519/A

**PROPERTIES**  
Plastic body  
0-220 cm measuring  
1 mm accuracy  
For adults and children  
Duvara monte



### Height Meter

S-519/B

**PROPERTIES**  
Aluminium body  
0-99 cm measuring  
1mm accuracy  
For babies

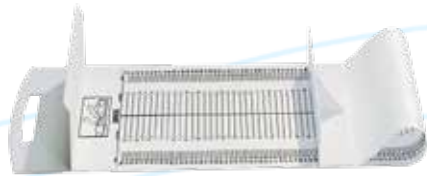

### Height Meter

S-519/C

**PROPERTIES**  
Plastic body  
10-99 cm measuring  
1 mm accuracy  
For babies



### Head And Body Measure

S-519/D

**PROPERTIES**  
Plastic body  
0-220 cm measuring  
1 mm accuracy  
Otomatik geri sarma

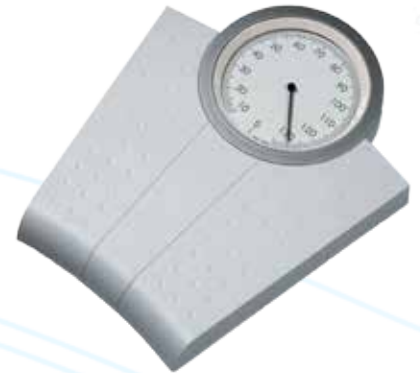

### Mechanical Scale

S-520

**PROPERTIES**  
Profile body  
150 kg measuring  
5-10 gr accuracy  
Mechanical



## Scale

S-520/A

### PROPERTIES

Digital and Mechanical  
180 kg measuring  
50 gr accuracy



## Portable Suction Unit

S-501

### PROPERTIES

Plastic body  
1 lt waste jar  
Bacteria filter  
220 V



## Portable Suction

S-502

### PROPERTIES

Plastic body  
1 lt waste jar  
Bacteria filter  
220 V  
With stand



## Oxygen Regulator

S-521

### PROPERTIES

Chrome coated brass body  
Flow adjustment screw  
Manometer for tube pressure  
Gaz çıkış basıncını gösteren manometre  
Double manometer



## Oxygen Regulator

S-521/A

### PROPERTIES

Chrome coated brass body  
Flow adjustment screw  
Manometer for tube pressure  
Gaz çıkış basıncını gösteren manometre  
Double manometer  
Acil çantalar için tasarlanmıştır



## Nitrous Oxide Regulator

S-522

### PROPERTIES

Chrome coated brass body  
Flow adjustment screw  
Manometer for tube pressure  
Gaz çıkış basıncını gösteren manometre  
Double manometer



## Flowmeter

S-524

### PROPERTIES

Chrome coated brass body  
Sterilizable damping cup  
Flow adjustment screw  
Exit pressure 0.15 L / min  
For oxygen



## Oxygen Manometer

S-525

### PROPERTIES

Chrome coated brass body  
Sterilizable damping cup  
Gaz ayar vidası



## Carbon Dioxide Tube

S-527

### PROPERTIES

10 lt  
Dikişsiz çelik boru  
TS EN ISO 9809-1 standardına ve Taşınabilir  
Basıncı Ekipmanlar Yönetmeliği'ne ( TPED-  
2010/35/EC) göre üretilmiş



## Oxygen Tube

S-528

### PROPERTIES

10 lt  
Dikişsiz boru  
TS EN ISO 9809-1 standardına ve Taşınabilir  
Basıncı Ekipmanlar Yönetmeliği'ne ( TPED-  
2010/35/EC) göre üretilmiş



## Oxygen Tube

S-529

### PROPERTIES

5 lt  
Dikişsiz boru  
TS EN ISO 9809-1 standardına ve Taşınabilir  
Basıncı Ekipmanlar Yönetmeliği'ne ( TPED-  
2010/35/EC) göre üretilmiş



## Oxygen Tube

S-530

### PROPERTIES

2 lt  
Dikişsiz boru  
TS EN ISO 9809-1 standardına ve Taşınabilir  
Basıncı Ekipmanlar Yönetmeliği'ne ( TPED-  
2010/35/EC) göre üretilmiş



### Aluminium Oxygen Tube

S-531

#### PROPERTIES

Alüminyum 5 lt oksijen tüpü  
TS EN ISO 9809-1 standardına ve Taşınabilir  
Basıncılı Ekipmanlar Yönetmeliği'ne ( TPED-  
2010/35/EC) göre üretilmiş



### Aluminium Oxygen Tube

S-532

#### PROPERTIES

Alüminyum 3 lt oksijen tüpü  
TS EN ISO 9809-1 standardına ve Taşınabilir  
Basıncılı Ekipmanlar Yönetmeliği'ne ( TPED-  
2010/35/EC) göre üretilmiş



### Aluminium Oxygen Tube

S-533

#### PROPERTIES

Alüminyum 1 lt oksijen tüpü  
TS EN ISO 9809-1 standardına ve Taşınabilir  
Basıncılı Ekipmanlar Yönetmeliği'ne ( TPED-  
2010/35/EC) göre üretilmiş



### Ambu Device

S-540

#### PROPERTIES

Silicon  
Autoclavable at 124 degrees  
Mask, Mouth opener, Tube connection hose  
Airway, Oxygen bag



### Ambu Device

S-541

#### PROPERTIES

For single use  
Mask, Tube connection hose, Oxygen bag



### Nebulization Device

S-542

#### PROPERTIES

2.5 lt water volume  
Ultrasonic steam  
220 V



### Nebulization Device

S-542/A

#### PROPERTIES

Short time medication  
With compressor  
Mouth mask  
220 V



### Air Bearing Pad

S-543

#### PROPERTIES

PVC antibacterial material  
Hava ayar sistemli motor  
30-120 Kg patient weight  
Prevents tissue and bed scars with diamond shapes  
220 V



### Alcohol Meter Device

S-545

#### PROPERTIES

Lion SD-2 model  
Results in 30 seconds  
Charge



### Alcohol Meter Device

S-546

#### PROPERTIES

Lion SD-400 model  
Results in 30 seconds  
Charge



### For Alcohol Meter Printer

S-547

#### PROPERTIES

For Lion SD-400 model  
Thermal print-head  
Easy and practical use



### Alcohol Meter Device

S-548

#### PROPERTIES

Fet brand  
Results in 30 seconds  
Easy and practical use  
Lighted display  
Fuel-cell sensor





Laryngoscope

S-550

**PROPERTIES**

304 Quality 18/8 chrome-nickel  
 Light on blade  
 3 Blades  
 Adult model  
 1-2-3 no blades



Laryngoscope

S-551

**PROPERTIES**

304 Quality 18/8 chrome-nickel  
 Light on blade  
 4 Blades  
 Adult model  
 0-1-2-3 no blades



Laryngoscope

S-551/A

**PROPERTIES**

304 Quality 18/8 chrome-nickel  
 Light on blade  
 3 Blades  
 Child and newborn model  
 00-0-1 no blades



Laryngoscope

S-551/B

**PROPERTIES**

304 Quality 18/8 chrome-nickel  
 Light on blade  
 5 Blades  
 Adult model  
 0-1-2-3-4 no blades



Head Mirror

S-552

**PROPERTIES**

Without light  
 9 cm head-piece diameter  
 Adjustable head-band



Head Mirror

S-553

**PROPERTIES**

With light  
 5,5 cm head-piece diameter  
 Adjustable head-band  
 6 V adapter output



## Otoscope

S-555

### PROPERTIES

304 Quality 18/8 chrome-nickel body  
With bag  
3 V energy  
3 speculums



## Econom Set

S-556

### PROPERTIES

304 Quality 18/8 chrome-nickel  
With bag  
3 V energy  
3 speculums  
Otoscope and opthalmoscope  
Nose speculum, Throat mirrors



## Doppler

S-557

### PROPERTIES

Plastic body  
3 V energy  
High volume sound  
Volume adjustment, High efficiency



## Pneumatic Tourniquet

S-570/A

### PROPERTIES

Manometer with 700mmHg pressure  
Hand type pump  
Chrome coated manometer and pump



## Sphygmomanometer

S-571

### PROPERTIES

Manuel ölçüm  
Hand type pump  
Stethoscope  
Japanese



## Sphygmomanometer

S-571/A

### PROPERTIES

Manual measurement  
Hand type pump  
Muff with hook  
Pendant switch with spoon



**Bantigilasion Gun**

**S-573**

**PROPERTIES**  
 Profile body  
 For hemorrhoids  
 Air suction  
 Optional rubber bands



**Ear Cleaning Injector**

**S-574**

**PROPERTIES**  
 304 Quality 18/8 chrome-nickel  
 100 cc - 150 cc options  
 Two tips  
 Mirror



**Stethoscope**

**S-575**

**PROPERTIES**  
 Classical type



**Stethoscope**

**S-575/A**

**PROPERTIES**  
 Japanese type



**Carmen Cannula**

**S-576**

**PROPERTIES**  
 Single type  
 4-5-6 no tips  
 Sterilizable injector  
 Carmen oil 10 cc



**Carmen Cannula**

**S-577**

**PROPERTIES**  
 Double tips type  
 6-7-8-9-10-12 no tips  
 Sterilizable injector  
 Carmen oil 10 cc



### Plaster Cutting Motor

S-578

#### PROPERTIES

50 mm - 65 mm two tips  
Speed adjustment  
Two switches  
220 V



### Hysterosalpingography

S-579

#### PROPERTIES

Rubin cannula  
Used by gynecologists and radiologists  
for injecting colored fluid into uterus  
for Uterine Cavity imaging  
Metal body



### Gauze Bandage Cutting Scissors

S-580

#### PROPERTIES

304 Quality 18/8 chrome-nickel  
Holding part is painted and varnished  
26 cm



### Gauze Bandage Cutting Engine

S-580/A

#### PROPERTIES

220-240 V  
Blade size: 100 mm  
Cut width: 25 mm  
Engine power: 100 Watt



### Fetoscope

S-581

#### PROPERTIES

Aluminum body  
15.5 cm



### Hand Perforator

S-582

#### PROPERTIES

304 Quality 18/8 chrome-nickel  
Tip squeezing valve

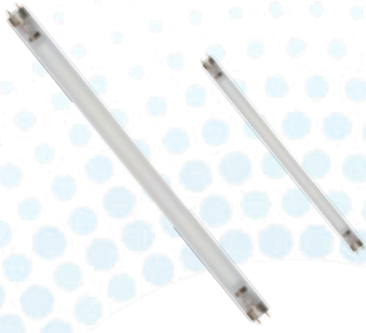

### Lamp

S-583

#### PROPERTIES

Ultraviolet lamp  
15 watt-30 watt options  
Destroying bacteria in air  
15 Watt length: 45 cm  
30 Watt length: 90 c



### Infrared Lamp

S-584

#### PROPERTIES

For Physiotherapy purposes  
250 Watt heat power



### Cold chain Case

S-585

#### PROPERTIES

4-8-16-24 lt sizes  
3-6 hours protection  
Cold chain case



### Cold chain Case

S-586

#### PROPERTIES

1 lt volume  
1-3 hours protection

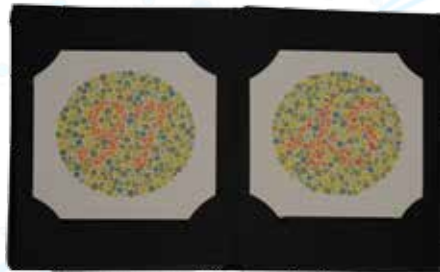

### Color Blindness Book

S-587

#### PROPERTIES

Ishihara



### Hot Water Bag

S-588

#### PROPERTIES

500 cc bag capacity



Coccyx  
Cushion

S-589



Ice  
Bag

S-590



Bedpan

S-591



Plastic  
Urinary

S-592



Medical Waste  
Bin

S-593



Medical Waste  
Bin

S-594

**PROPERTIES**

Scaled

**PROPERTIES**

Sharp box  
5 lt capacity  
Plastic  
Locked lid

**PROPERTIES**

Sharp box  
1 lt capacity  
Plastic  
Locked lid



Medical Waste  
Bin

S-595



Medical Waste  
Bin

S-596

**PROPERTIES**

Sharp box  
10 lt capacity  
Plastic  
Locked lid

**PROPERTIES**

Sharp box  
30 lt capacity  
Plastic  
Locked lid



Oda  
Nemlendiricisi

S-597

**PROPERTIES**

Ofis ve seyahat için ideal  
0.5 lt çıkarılabilir su tankı  
Su bitince otomatik kapanma  
20 m<sup>2</sup>'ye kadar olan odalar için etkinlik  
Düşük enerji tüketimi  
Mikro-ince ultrasonik atomizasyon

# *Understanding Sustainable Production*

Our selection of raw materials used in our products , our production process , from the packaging to the shipping process every step we can keep using cleaner methods of our world.



[www.erpamedikal.com](http://www.erpamedikal.com)

CE

Erpa Tıbbi Malzeme Gıda ve Temizlik Hizmetleri San. ve Tic. Ltd. Şti.

**HEADQUARTER:** Molla Gürani Mahallesi Oğuzhan Caddesi No:21/A Fındıkzade - Fatih / İstanbul

**FACTORY:** Gençosman Mahallesi Doğanbey Caddesi No:66/68 Güngören / İstanbul

Phone: +90 212 621 31 97-98 Fax:+90 212 531 05 04-24  
Web: [www.erpamedikal.com](http://www.erpamedikal.com) E-mail: [erpa@erpamedikal.com](mailto:erpa@erpamedikal.com)