

Front view

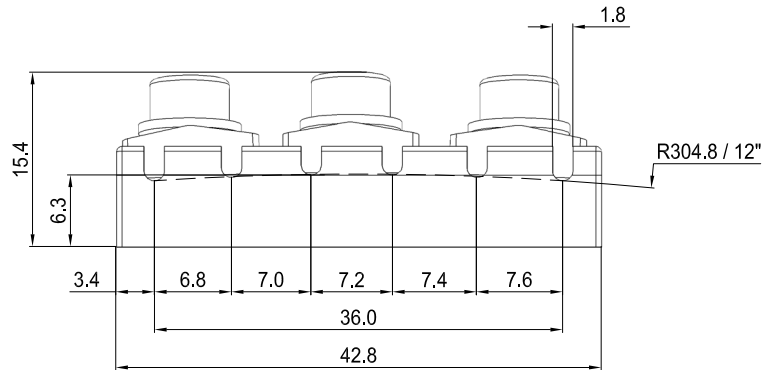

Side view

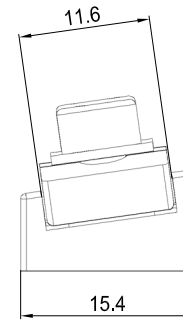

Isometric view

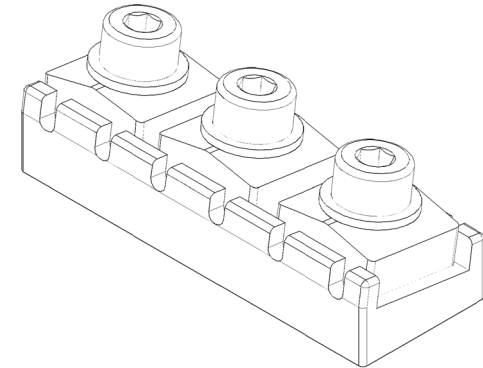

Top view

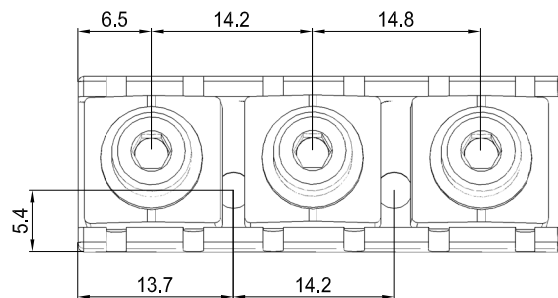

LN6-L3 Locking Nut

Notes:

- All measures in [mm].
- All metal parts are milled only from solid bars of specially selected STAINLESS STEEL.
- All standard parts are also from STAINLESS STEEL.
- Fretboard radius - R304.8 / 12".
- Orientation - **LEFT** handed.
- **LN6-L3** Locking Nut mounting - from underneath (by two metric thread screws) and from above (by two wood screws).
- **LN6-L3** replace all Locking Nuts with width close to 42.8mm or similar, described as **L3**.